

Controls

- Basic
- Comfort
- Comfort Plus



Certain computer programs contained in this product [or device] were developed by HygroMatik GmbH ("the Work(s)").

Copyright © HygroMatik GmbH [01.10.2013]

Controls B-C-CP

All Rights reserved.

HygroMatik GmbH grants the legal user of this product [or device] the right to use the Work(s) solely within the scope of the legitimate operation of the product [or device]. No other right is granted under this licence. In particular and without prejudice to the generality of the foregoing, the Work(s) may not be used, sold, licensed, transferred, copied or reproduced in whole or in part or in any manner or form other than as expressly granted here without the prior written consent of HygroMatik GmbH.

Information in this manual is subject to change or alteration without prior notice.



Warning, Hazardous Voltage: All work to be performed by trained personnel only. All electrical installation and servicing of the electrical components of this unit to be performed by qualified electricians only. Disconnect power supply before installation and servicing!

1. Introduction	5
1.1 Typographic Distinctions	5
1.2 Documentation	5
1.3 Directions for Use	6
2. Safety Notes	7
2.1 Overview	7
2.2 Guidelines for Safe Operation	7
2.3 Disposal after Dismantling	8
3. Adjustment of Control to the Control Signal	9
3.1 Brief Description of Controls	9
3.2 Explanation of Settings	9
4. Basic - Control	21
4.1 Basic Controls	21
4.2 Basic Construction	22
4.2.1 Basic Display Unit	22
4.3 Basic Main PCB	23
4.4 Parameter Setting with Jumpers	23
4.4.1 Brief Description of Jumpers	25
4.4.2 Explanation of Jumper Functions	26
4.4.3 Description of Potentiometer	29
4.4.3.1 Potentiometer P1 / Steam Generation Output Limitation	29
4.4.3.2 Potentiometer P2 / Pump Run Time	29
4.4.4 Potentialfree Outputs	29
4.4.4.1 Collective Fault - Base Relay	29
4.4.4.2 Humidification:	30
4.4.4.3 Signal Output	30
5. Comfort and Comfort Plus	31
5.1 Construction of Comfort and Comfort Plus	31
5.1.1 Comfort / Comfort Plus Display and Operation Unit	32
5.1.2 Controls Comfort and Comfort - Plus	33
5.1.3 Manual Flush	34
5.2 Signal Relay PCB (Optional)	35
5.2.1 Refitting of Signal Relay PCB:	36
6. Operational Conditions (dependent on unit type)	37
6.1 Fault Messages (Comfort / Comfort Plus - Control)	38
7. Software Menu and Parameter Setting	41
7.1 Menu Configuration	42
7.2 Readout Mode	43
7.2.1 Direct Entry of a Desired Value in Readout Mode	43
7.3 Menu Mode	44
7.3.1 Language Menu	44
7.3.2 Start-Up Parameters Menu	45
7.3.2.1 Control Parameters Submenu	45

7.3.2.2 System Test Submenu	47
7.3.3 Electronic Name Plate Menu	49
7.3.4 Parameter Setting Menu	49
7.3.4.1 Summary Table of Parameters	51
7.4 Description of Parameters	53
7.4.1 T0 Time Clock	59
7.5 Computer Interface	60
7.6 Parameter Setting without Codes (P0=000) / Basic Customer Level	61
7.6.1 Programming Sequence for Modifying Parameter A4:	61
7.7 Parameter Setting with Codes (P0=010) / Advanced Customer Level	63
7.7.1 Programming Sequence for Modifying Parameter U6:	63
7.7.2 Programming Parameter E3	65
8. Twin Cylinder Units (HyLine 60-116) and Double Units (HeaterLine 60-90)	66
9. Malfunctions and Messages / Conditions	68
10. Basic PCB Connections	77
11. Wiring Diagram	79
12. Technical Specifications	90

1. Introduction

Dear Customer,

Thank you for choosing a HygroMatik steam humidifier.

HygroMatik steam humidifiers represent the latest in humidification technology.

They will impress you with their safety, ease of use and economical operation.

In order to operate your HygroMatik steam humidifier safely, properly and efficiently, please read these operating instructions.

Employ your steam humidifier only in sound condition and as directed. Consider potential hazards and safety issues and follow all the recommendations in these instructions.

If you have additional questions, please contact us:

Airtrend Ltd.

Kumanovska 14, 11000 Beograd

Tel: 011/383 68 86, 308 57 40

Faks: 011/3444 113

e-mail: gobrid@eunet.rs

For all technical questions or spare parts orders, please be prepared to provide unit type and serial number (see name plate on the unit).

1.1 Typographic Distinctions

- preceded by a bullet: general specifications.
- » preceded by an arrow: Procedures for servicing or maintenance which should or must be performed in the indicated order.
- Installation step which must be checked off.
- italics* Terms used with graphics or drawings.

1.2 Documentation

Retention

Please retain these operating instructions in a secure, always accessible location. If the product is resold, turn the documentation over to the new operator. If the documentation is lost, please contact HygroMatik.

Versions in Other Languages

These operating instructions are available in several languages. If interested, please contact HygroMatik or your HygroMatik dealer.

1.3 Directions for Use

The proven principle of heating water by the use of electric immersion heaters is exploited to generate steam. Using different tap water qualities or partial softened water (all humidifier types) or fully demineralized water / condensate water (only for humidifier type HeaterLine, HeaterCompact/Kit and HeaterSlim).



Warning: HygroMatik steam humidifiers emit steam with a temperature of 100° C. The steam may not be inhaled directly.

Only qualified and authorised personnel may operate the unit. Persons transporting or working on the unit, must have read and understood the corresponding parts of the Operation and Maintenance Instruction and especially the chapter 2. „Safety Notes“. Additionally, operating personnel must be informed of any possible dangers. You should place a copy of the Operation and Maintenance Instruction at the unit's operational location (or near the unit).

The steam humidifier is not qualified for exterior application.

2. Safety Notes

2.1 Overview

These safety notes are required by law. They promote workplace safety and accident prevention.

Warnings and Safety Symbols

The safety symbols below identify sections containing warnings about hazards or potential dangers. Please familiarize yourself with these symbols.



Warning: Failure to observe this warning may result in serious injury or death and/or damage to the unit.



Danger, Hazardous Voltage: Hazardous electrical current! Failure to observe this warning may result in injury or even serious injury or death.



Warning: Failure to follow these instructions may result in damage to the unit due to electrostatic discharge. The electronic components of the humidifier control are very sensitive to electrostatic discharges. In order to safeguard these components during installation and servicing, steps must be taken to protect against ESD.



Reminder: Materials and consumables must be handled and/or disposed of as required by law.



Note: Appears before explanations or cross-references which refer to other sections of the operating instructions.

2.2 Guidelines for Safe Operation

Overview

Obey all safety notes and warnings present on the unit. In case of a malfunction, switch off the unit immediately and prevent a restart. Repair malfunctions promptly. After any repair work, have qualified personnel check the safe operation of the unit.

Use original spare parts only. Additional national safety regulations also fully apply to the operation of this unit.

This unit is not designed for the use by persons (also children) with limited physical, sensory and mental abilities - or without knowledge and experience. Unless they are supervised or trained by a person, who is responsible for their safety.

Supervise children in order to ensure that they will not play with the unit.

The unit is only allowed to work with connected steam hose that safely leads the steam.

Accident Prevention Regulations



Attention: In the event of leaky or faulty components uncontrolled hot steam may flow.

HygroMatik steam humidifiers are IP20-protected. Make sure that the unit is protected from drips in its installed location.

Installing a humidifier in a room without water discharge requires safety devices to protect against water leakages.

Accident Prevention Regulations



Comply with the Accident Prevention Regulation Electrical Systems and Equipment to prevent injury to yourself and others.

Operation of the Unit:

Do not perform any work which compromises the safety of the unit. Regularly check that all safety and monitoring devices are functioning normally. Do not remove or disable safety devices.

Installation, Dismantling, Maintenance and Repair of the Unit:

Disconnect unit components from power supply prior to maintenance or repair work.

Attaching or installing **additional components** is permitted only with the **written consent** of the manufacturer.

Electrical



Work on the electrical system must be performed by qualified personnel.

Disconnect unit components from power supply prior to work.

It is not allowed to connect the unit to DC voltage supply.

In case of a malfunction in the electrical power supply, switch off the unit immediately. Use only original fuses with the appropriate amperage rating. Regularly check the unit's electrical equipment. Promptly repair any damage, such as loose connections, burned wiring or defective electrical insulation. After proper electrical installation or repair, test all safety mechanisms (such as grounding resistance).

2.3 Disposal after Dismantling



Note: The operator is responsible for the disposal of unit components as required by law.

3. Adjustment of Control to the Control Signal

3.1 Brief Description of Controls

Control of the HygroMatik steam humidifier is performed by sophisticated microprocessors. These microprocessors use self-adaptive algorithms to intelligently select the steam humidifier's most economical mode of operation for the available water quality. Optimized start-up procedures ensure rapid steam production and quick responses to all control processes. The HygroMatik control regulates the entire blow-down cycle and the function of the water inlet solenoid valve. With the electrode steam humidifier, it provides self-monitoring control of the conductivity of the cylinder water. Naturally, HygroMatik microprocessor controls handle all standard control signals.

Three controls will be described in these instructions:

- Basic
- Comfort
- Comfort Plus

Note: The factory setting for the controls is to an „External control signal, 0-10 VDC“ if no other setting is described in the delivery note of the humidifier.

3.2 Explanation of Settings

The following descriptions of settings for the possible, acceptable control signals are presented in parallel for the HygroMatik controls Basic, Comfort and Comfort Plus.



Note: If the the Basic control is used, parameters may only be modified by changing jumper settings. On the other hand, software parameter setting is possible with the Comfort or Comfort / Plus. If a Basic is upgraded to a Comfort / Plus, the jumper settings are ignored - the Comfort / Plus operates only as specified by the set software parameters.

For more information about modifying parameters, also see Section „Parameter Setting menu“, or see Section „Parameter Setting with jumper“.

The Basic control is depicted as shown below:



The Comfort control is depicted as follows:

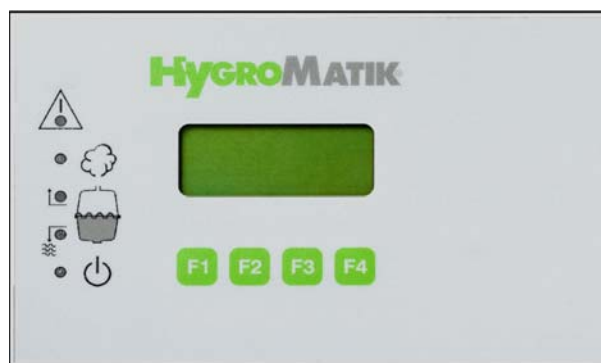





The Comfort Plus control is depicted as follows:



Unlike the Comfort, the Comfort Plus is equipped with an additional encoder knob for easy use. Turning the knob left or right is equivalent to pressing the software keys “up arrow” or “down arrow”.

Pushing down the encoder corresponds to pressing the software key “Enter”, also see Section „Comfort and Comfort Plus“.

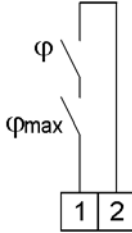
Safety Interlock (Enable)

 <p>Basic</p>	 <p>Comfort / Comfort Plus</p>
<p>Every HygroMatik humidifier is equipped with terminals 1 and 2. These terminals function as the connection for the safety interlock. The safety interlock contacts, such as the max.-hygrostat, vane relay, duct pressure sensor, air interlock etc., are laid in a series between terminals 1 and 2. The enable switch or safety interlock must be closed in order for the humidifier to operate.</p>	
<div style="text-align: center;">  <p><i>Humidifier Terminals</i></p> </div>	
<div style="display: flex; align-items: center;">  <p>Warning: Installation of a max.-hygrostat in the safety interlock is absolutely necessary to protect against humidity sensor failure or overhumidification.</p> </div>	
<p>Double-cylinder units are provided with a standard enable switch, i.e. both cylinders are enabled simultaneously. Upon request, each cylinder can be equipped with its own enabler switch.</p>	
<div style="display: flex; align-items: center;">  <p>Warning: Contacts laid between terminals 1 and 2 must be potentialfree and rated for 230V switches.</p> </div>	



Basic



Comfort / Comfort Plus

Mutual Safety Interlock of Humidifiers Operated in Parallel (optional)

If desired, you may also connect two humidifiers to a mutual safety interlock.

For the mutual safety interlock, terminals 11 and 14 of relay K12 of the first humidifier must be connected to terminals 1 and 2 of the second humidifier as specified in the diagram.

Wiring diagrams are available from HygroMatik on request.

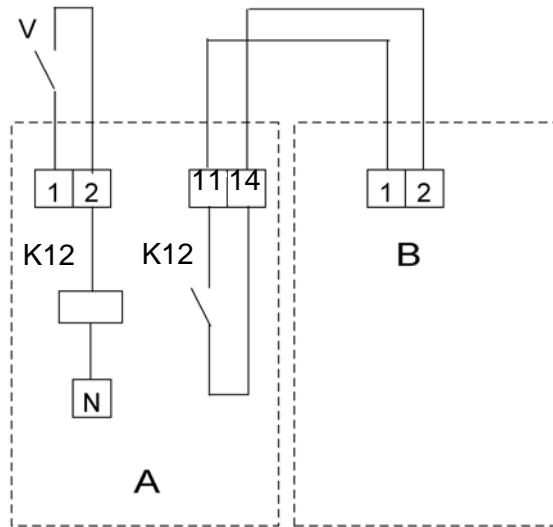

A: Terminals Humidifier 1

B: Terminals Humidifier 2

Optional: Shared Enable Switch for Two Humidifiers

1 Step Controls

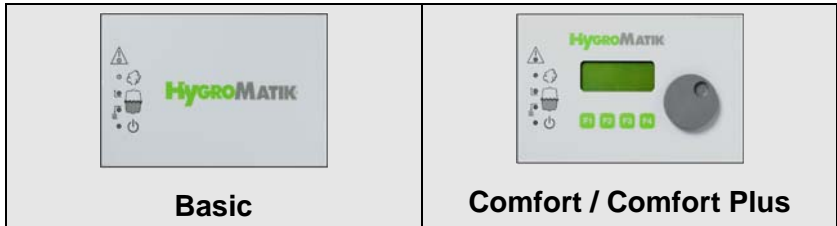

With 1-Step Controls, the external control hygrostat or control switch is wired in series with the contacts of the safety interlock.

Warning: Contacts laid between terminals 1 and 2 must be potentialfree and rated for 230V switches.

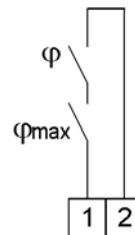

Terminals single-cylinder and double-cylinder humidifiers



Note: Controls are typically set to an external control signal of 0-10 V DC. For 1-step controls, the following modifications must be made:

For 1-step controls the jumpers must be set as indicated below:

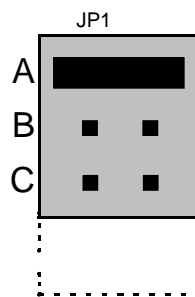

For 1-step controls, Parameter U6 must be set to "1-step," also see Section „Parameter Setting with Codes (P0=10) / Advanced Customer Level“



Warning: Set controls so that the steam humidifier does not switch on and off more frequently than 4 times per minute (flut-tering control leads to premature wear of the main contactor).

**Proportional Control
with an External Control
signal**

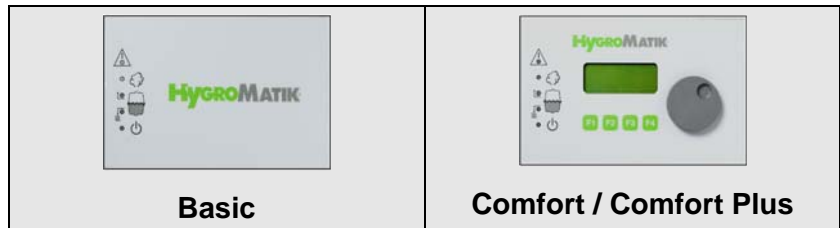

The control can be adjusted to the following external control signals:

- 0(2) - 5 V DC
- 0(2) - 10 V DC
- 0(4) - 20 V DC
- 0(4) - 10 mA DC
- 0(4) - 20 mA DC
- 0 - 140 Ohm

The factory setting is a control signal of 0-10V.

The steam humidifier typically switches into standby mode with a (control) signal of less than 20%, i.e. no steam is produced. With a (control) signal of 25% the humidifier resumes operating.

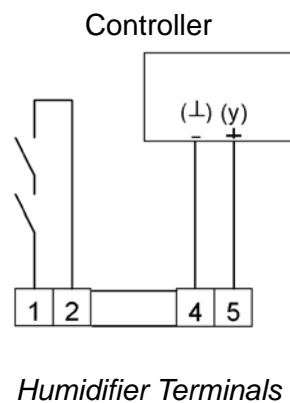

With a signal of 20%, humidification output reaches 5% of maximum output for HeaterLine humidifiers and 10% for electrode humidifiers. Below that, the unit switches off. At lower steam output levels, steam would condense in the cylinder or steam hose and fail to reach its intended location.



Connection for an external controller, single-cylinder and double-cylinder humidifier





Note: With double-cylinder humidifiers the control for the second cylinder (the right one) is adjusted to an „external control signal, 0-10V“ (factory setting).

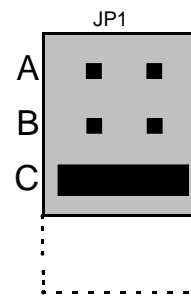
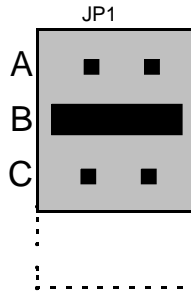
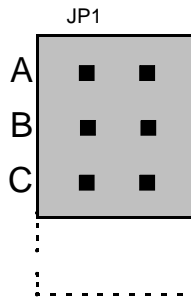

 <p style="text-align: center;">Basic</p>	 <p style="text-align: center;">Comfort / Comfort Plus</p>
	<p>Note: If the connecting wires carrying the controller signal are able to pick up electromagnetic signals from cables laid in the immediate area, the humidifier could operate unchecked. Therefore, we strongly recommend laying controller signal wires with shielding laid to fit the dimensions of the controller.</p>
<p>For a proportional control connected to an external control signal, the jumpers on the PCB must be connected as follows:</p>	<p>For a proportional control connected to an external control signal, Parameters U6 and E3 must be set as indicated below, also see Section „Parameter Setting with Codes (P0=010) / Advanced Customer Level“.</p>
<p>Setting for External Control Signal: 0(2) - 10 V DC</p>	<p>Parameter set U6 to “external controller” and E3 to “0-10 V” Also see Section „Parameter Setting with Codes (P0=010) / Advanced Customer Level“</p>
<p>Setting for External Control Signal: 0(4)-20 mA</p>	<p>Parameter set U6 to “external controller” and E3 to “0-20 mA” Also see Section „Parameter Setting with Codes (P0=010) / Advanced Customer Level“ .</p>
<p>Setting for External Control Signal: 0-140 Ohm</p>	<p>Parameter set U6 to “external controller” and E3 to “0-140 Ohm” Also see Section „Parameter Setting with Codes (P0=010) / Advanced Customer Level“.</p>



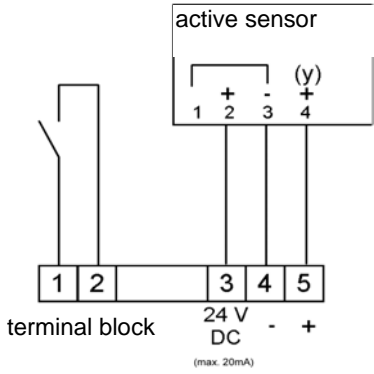

**Proportional Control
with Built-In PI-Controller**

 <p>Basic</p>	 <p>Comfort / Comfort Plus</p>
<p>(Function not available)</p>	<p>An active humidity sensor can be directly connected to the Comfort or the Comfort Plus.</p> <p>Upon request, HygroMatik will provide an active sensor with a control signal of 0-10 V DC. Sensors with other control signals can also be used; the control need only be set to them.</p> <p>Acceptable Output Signals from an Active Sensor (Parameter E3)</p> <p>0(2) - 5 V DC 0(2) - 10 V DC 0(4) - 20 V DC 0(2) - 10 mA DC 0(4) - 20 mA DC 0-140 Ohm</p> <p><i>Active Sensor Connector Strip</i></p>  <p><i>Connection: Active Sensor, one-cylinder and double-cylinder humidifier; voltage output</i></p>

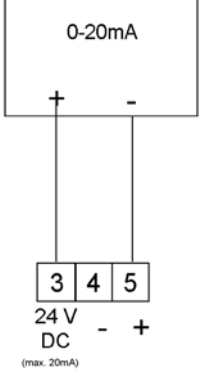

 <p>Basic</p>	 <p>Comfort / Comfort Plus</p>
	<p>Note: With double-cylinder humidifiers the control for the second cylinder (the right one) is adjusted to an „external control signal, 0-10V“ (factory setting).</p>
	<p>Active sensor</p>  <p><i>Humidifier Terminals</i></p> <p><i>Connection: active sensor; current output, single-cylinder and double cylinder units, two-wire system</i></p> <p>Setting the parameter to the output signal from the active sensor.</p>
<p>Setting for Sensor Signal: 0(2)-10 V DC</p>	<p>Parameter Set U6 to “PI-control” and E3 to “0-10 V”</p> <p>The desired relative humidity value is set at Parameter P8</p>

	 <p>Basic</p>	 <p>Comfort / Comfort Plus</p>
Setting for Sensor Signal: 0(4)-20 V DC		Parameter Set U6 to “PI-control” and E3 to “0-20 V” the desired relative humidity value is set at Parameter P8
Setting for Sensor Signal: 0(2)-10 mA DC		Parameter Set U6 to “PI-control” and E3 to “0-10 mA”; (the desired relative humidity value is set at Parameter P8)
Setting for Sensor Signal: 0(4)-20 mA DC		Parameter Set U6 to “PI-control” and E3 to “0-20 mA”; (the desired relative humidity value is set at Parameter P8)
Setting for Sensor Signal: 0- 140 Ohm		Parameter Set U6 to “PI-control” and E3 to “0-140 Ohm”; (the desired relative humidity value is set at Parameter P8)

Proportional Control with Hygrostat Type HPH or HRP

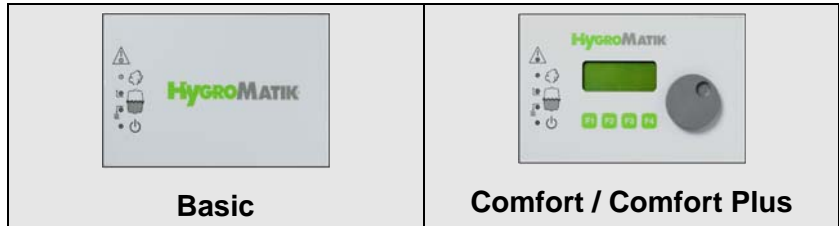

The duct humidistat Type HPH or the room humidistat Type HRP send a proportional resistance output signal. In this way a proportional band of 7% RH is achieved. This signal is to be used for simple control functions.
Connect the hygrostat as indicated below:

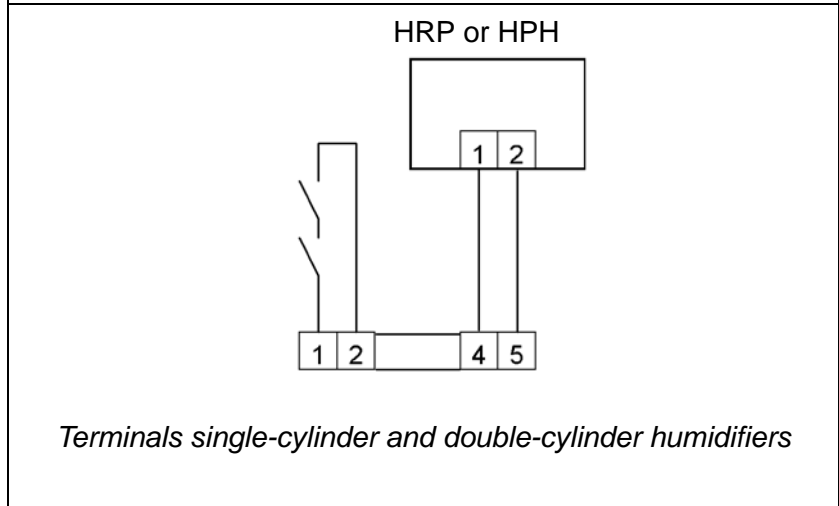





Note: The control must be set for an external control signal of 0-140 Ohm.

1 Step Control Dehumidifier

Setting the control, also see Section: "Proportional Control with an External Control signal" on Page 14.

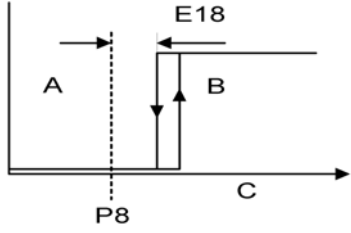
The potentialfree output from a signal relay may be used for 1 step control of a dehumidifier. In this case, Parameter U6 **Operating Mode** is set to the operating mode "PI control" .
The switchover point between humidification and dehumidification is specified by the parameters **P8 Set Value RH** and **E18 Offset for Dehumidifier**. The hysteresis of 1% for dehumidification cannot be modified.

 <p>Basic</p>	 <p>Comfort / Comfort Plus</p>
	 <p>A: Humidification B: Dehumidification C: .Rel. Humidity % RH</p>
	<p>Example:</p> <p>P8 Set value RH = 50%</p> <p>E18 Offset for Dehumidifier = 5%</p> <p>Switchover point humidification - Dehumidification = 55% + 1% hysteresis</p> <p>In this example, the dehumidifier switches on at 56% RH and switches off at 55% RH.</p> <p>Note: To use this function, the base relay or one of the optional signal relays must be programmed for the function “dehumidification” and the dehumidifier must be connected to this relay.</p>

4. Basic - Control

The functional microprocessor control Type Basic is set to the standard requirements of the user in the customer's usage and information materials.

It features:

- integrated P-controller function for use with HygroMatik humidity sensor Type HP 148 (duct) or HRP (room)
- proportional or 1 step controls
- 5 indicator lamps for readout of important operating data and fault messages
- 1 potentialfree remote signal (4 additional signals optional for relay PCB)
- Fuzzy Logic
- Stand-By blow-down to prevent standing cylinder water. After a long period of time without steam production, the cylinder is completely drained.

4.1 Basic Controls

The HygroMatik Control Type Basic accepts the control types indicated below:

Controls, Basic Control
1 step control (on/off)
Proportional control with external controller
Proportional Control with Hygromatik Hygrostat Type HPH or Type HRP

In Section „Adjustment of Control to the control signal“ you will find an explanation of the possible settings for the Type Basic control.

4.2 Basic Construction

The HygroMatik control Type Basic consists of a main PCB and a display unit with icons to describe the LED.

4.2.1 Basic Display Unit



Using 5 LED, the display unit of the Basic Control provides the user with information about operational conditions and fault messages:

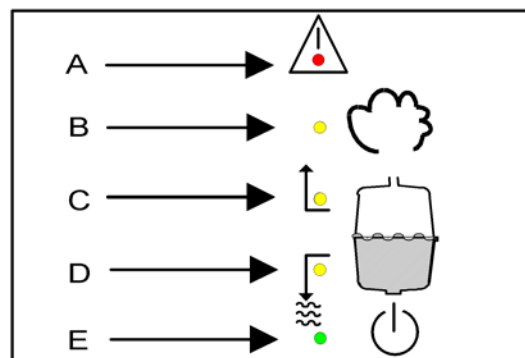

- | | |
|----------------|--------------|
| A: Malfunction | (red LED) |
| B: humidifying | (yellow LED) |
| C: Filling | (yellow LED) |
| D: Blow-down | (yellow LED) |
| E: Stand-by | (green LED) |

The red LED blinks to indicate a humidifier malfunction. The humidifier shuts off automatically, see Section „Malfunctions and Messages / Conditions“.

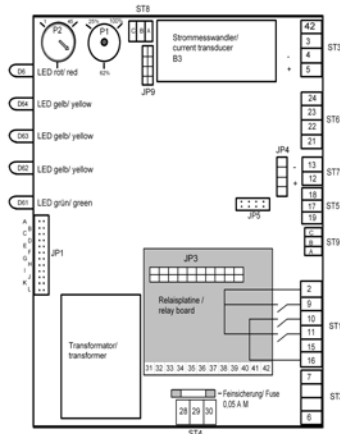

4.3 Basic Main PCB

Also see the detailed illustration of the main PCB in Section „Basic PCB Connections“.

On the main PCB, jumper strip JP1 and two potentiometers are located; control function is determined by how these are set. Descriptions of this appear in the following sections:

4.4 Parameter Setting with Jumpers

Normally, settings (parameters) for the Basic Control can only be modified using jumpers.

Jumpers are small blocks with two pins over which a circuit plug can be placed, creating an electrical contact inside the plug.

Example: jumper open

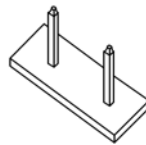

jumper jumpered

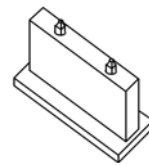

The jumper is referred to as “open” if there is no plug on either pin or if only one of the pins is covered.



Warning: Change jumper settings only when the system is turned off. Otherwise, the control could be damaged or unpredictable functioning could occur.

The jumper strip JP1 has 12 jumper positions, designated by the letters A to L.

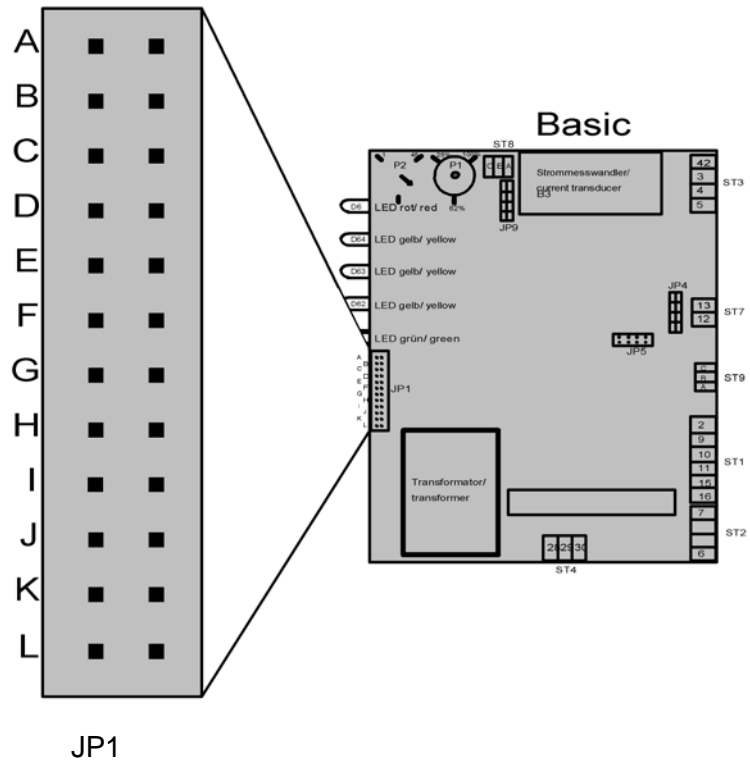

4.4.1 Brief Description of Jumpers

Jumper	Jumper Function
A	Control: 1 step control (On/Off) or factory programmed*
B	Control: 0-20 mA DC external signal or factory programmed*
C	Control: 0-140 Ohm external signal or factory programmed*
A+B+C open	control: 0-10 V DS external signal (factory programmed , other controls signals can be programmed ex works)
D	Stand-by Draining Off
E	Main contactor switched off during blow-down
F	Less frequent partial blow-downs (-50%)
G	More frequent partial blow-downs (+100%)
H	Full blow-down switched off
F+G+H	Fully demineralized feed water
I	(no jumper placed in the factory)
J	(no jumper placed in the factory)
K	(no jumper placed in the factory)
L	(no jumper placed in the factory)

*: If jumpers A, B and C are not covered, this constitutes the factory setting for an **external control signal 0-10 V DC**. Other control signals (0-20 V DC, 0-10 mA DC) can also be handled by the Basic. However, the control must be programmed for them in the factory.

4.4.2 Explanation of Jumper Functions

Jumper A / 1 Step Control or Factory Programmed

If only this jumper is jumpered, the humidifier functions in a 1 step operation (On/Off).

If jumpers A, B and C are open, this is the factory setting for an external control signal of 0-10 V DC.

Jumper B / External Control Signal 0-20 mA DC or Factory Programmed

If only this jumper is jumpered, the humidifier expects an external control signal of 0-20mA DC.

If jumpers A, B and C are open, this is the factory setting for an external control signal of 0-10 V DC.

Jumper C / External Control Signal 0-140 Ohm or Factory Programmed

If only this jumper is jumpered, the humidifier expects an external control signal of 0-140 Ohm.

If jumpers A, B and C are open, this is the factory setting for an external control signal of 0-10 V DC.

Jumper D / Stand-By Blow-Down

If this jumper is jumpered, the “stand-by blow-down” function is inactive.

If the external control or hygrostat has not ordered any humidification from the humidifier for a long while, an automatic stand-by complete blow-down occurs after a set period (12 hours).

The standard setting for the “stand-by blow-down” function is active.

Jumper E / Main Contactor Switched Off at Blow-Down

(Function only valid for electrode steam humidifiers)

The state of the circuit for the main contactor is specified with Jumper E.

Main contactor on: Jumper open
(standard setting)

Main contactor off: Jumper jumpered

The setting “main contactor off” specifies that the electrodes are disconnected from the power supply during blow-down. This setting may be advisable if the power line is run through a residual current circuit breaker (FI).

Jumper F / Less Frequent Partial Blow-Down (-50%)

If this jumper is jumpered, the “less frequent partial blow-down (-50%)” function is active.

The control periodically performs a partial draining of the cylinder (partial blow-down) in order to dilute the cylinder water; salt concentrates in it during routine operation because only pure water is evaporated.

If less conductive feed water is used (= lower salt content), it may be advisable to perform partial blow-downs less often to ensure that the humidifier always attains nominal steam output efficiently (only applies to electrode steam humidifiers).

Before modifying this parameter, please consult with HygroMatik.

Jumper G / More Frequent Partial Blow-Down (+100%)

If the jumper is jumpered, the “more frequent partial blow-down (+100%)” function is active.

The control periodically performs a partial draining of the cylinder (partial blow-down) in order to dilute the cylinder water; salt concentrates in it during routine operation because only pure water is evaporated.

If highly conductive feed water is used (= higher salt content), it may be advisable to perform partial blow-downs more often in order to minimize electrode corrosion or remove more calcium build-up.

Before modifying this parameter, please consult with HygroMatik.

Jumper H / Full Blow-Down Switched Off

If this jumper is jumpered, the “full blow-down switched off” function is active.

In addition to partial cylinder drainage (partial blow-down, see above), the control also performs a complete blow-down every 5-8 days of continuous operation.

If feed water with very low conductivity is used (= very low salt content), it may be advisable to deactivate the complete blow-down to ensure that the humidifier always attains nominal steam output efficiently (only applies to electrode steam humidifiers).

Before modifying this parameter, please consult with HygroMatik.

Jumper F+G+H / Fully Demineralized Feed Water

(this function is only valid for heater element humidifiers of Type HeaterLine)

If all three jumper are jumpered, the “fully demineralized feed water” function is active.

No partial and total cylinder blow-downs are necessary when using fully demineralized water. The “fully demineralized water” function prevents blow-downs.



Note: This function should not be activated when using electrode steam humidifiers of Type HyLine, CompactLine or Mini-Steam.

Jumper I

The standard setting for this jumper is open.



Note: This jumper may not be jumpered or only jumpered after consultation with HygroMatik.

Jumper J

The standard setting for this jumper is open.



Note: This jumper may not be jumpered or only jumpered after consultation with HygroMatik.

Jumper K

The standard setting for this jumper is open.



Note: This jumper may not be jumpered or only jumpered after consultation with HygroMatik.

Jumper L

The standard setting for this jumper is open.



Note: This jumper may not be jumpered or only jumpered after consultation with HygroMatik.

Jumper E and J inverted

After the preprogrammed number of operations of the main contactor (K1) the HygroMatik control provides the message "Maintenance K1". During this, the green LED blinks rapidly. By appropriately setting of the jumpers, this message can be reset. Therefore please turn off the unit and identify the status (open or closed) of the jumpers E and J. By inserting or removing the jumpers create inverted status of jumpers. Turn on the unit for about 5 seconds. Then turn off the device and restore the old status of the jumpers. This resets the message.

4.4.3 Description of Potentiometer

4.4.3.1 Potentiometer P1 / Steam Generation Output Limitation

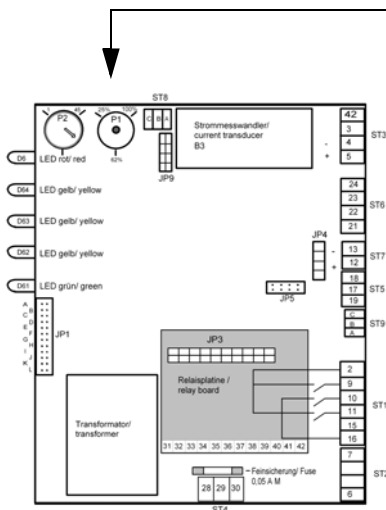

The control includes a Potentiometer P1 for setting the steam generation output limitation. Using the steam generation output limitation, the steam output can be set to a value between 25% and 100% of nominal output.

Limitation of steam output may be required for better control.

4.4.3.2 Potentiometer P2 / Pump Run Time

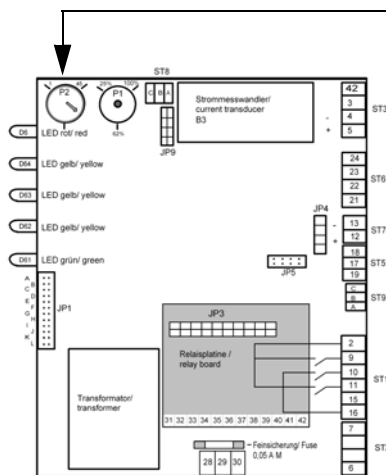

The control includes an additional Potentiometer: Potentiometer P2. This is used to set the pump run time during partial blow-down. The Potentiometer is properly set to the delivered humidifier type.

Depending on water quality, resetting the pump run time may be advisable. The following may apply:

very high conductivity of feed water = longer pump run time

very low conductivity of feed water = shorter pump run time

Please get in contact with HygroMatik before modifying this parameter.

4.4.4 Potentialfree Outputs

The rated load of the relay contact is 250V/8A.

4.4.4.1 Collective Fault - Base Relay

The Basic Control is normally supplied with a base relay programmed for a collective fault i.e. the base relay is triggered in case of a malfunction. The potentialfree contact is shipped as a two-way contact.

The connection terminal is located on the main PCB (normally open contact: connection terminals 28 and 30; normally closed contact: terminals 28 and 29).

Collective fault reporting includes the following fault messages:

- “blow-down fault”
- “fault filling”
- “maintenance” (only with electrode steam humidifiers)
- “fault main cont.”
- “fault thermo sensor” (only with unit Type HeaterLine)

The switching signal which switches over the base relay may be modified using Parameter E5. For an overview of possible fault messages, see Section: “Summary Table of Parameters” description of Parameter E5. The factory setting for the switching signal is “collective fault.”

Fault Name		Unit Type	
		HyLine, CompactLine, MiniSteam	HeaterLine, Heater- Compact
Blow-down fault	F1	x	x
Thermo sensor activated	F2		x
Max.-level	F3		x
Fault filling	F4	x	x
RH Sensor fault	F6	x	x
Fault Sensor	F7		x
Maintenance	F8	x	
Steam-down time	F8		x
Fault main cont.	F10	x	x
System Failure	F9	x	x
Lost Ground Control		x	x

4.4.4.2 Humidification:

The message “humidification” can be accessed directly on the main contactor as specified in the wiring diagram.

4.4.4.3 Signal Output

On the main PCB, a signal output is located at terminals 12 (+) and 13 (-). This output operates according to the set control mode as follows:

- If an external control signal is used (0 (2) - 10 V DC, 0 (4) - 20 mA DC, 0 - 140 Ohm), a proportional 0-10 V DC signal from the external control signal is displayed.
- If an PI-controller is used (= an active humidity sensor is connected), then the internal control signal of the humidifier is displayed as a proportional 0 - 10 V DC signal. This 0 - 10 V DC signal can be used as „external control signal“ for further humidifiers.

5. Comfort and Comfort Plus

The HygroMatik microprocessor controls Type Comfort / Comfort Plus are particularly user-friendly controls which give the user a fount of information.

The Comfort / Comfort Plus Controls feature e.g.:

- proportional or 1 step control
- an illuminated, alphanumeric LCD-display for readout and programming
- keys for direct communication with the control unit
- integrated PI-controller
- an (optional) RS232 or RS485 interface as the basis for the Modbus RTU protocol
- 5 indicator lamps for readout of important operational data
- 1 potentialfree remote signal (an additional 4 optional)
- Stand-By blow-down to prevent standing cylinder water. After a long period of time without steam production, the cylinder is completely drained.

The information is provided by indicator lights and the lighted display. The standard display shows the current steam output.

5.1 Construction of Comfort and Comfort Plus

Both the HygroMatik Comfort and Comfort Plus consist of a main PCB and a display unit with back-lighted display.

5.1.1 Comfort / Comfort Plus Display and Operation Unit

Comfort



Comfort - Plus



Unlike the Comfort, the Comfort Plus is equipped with an additional encoder knob for easy use. Turning the knob left or right is equivalent to pressing the software keys “up arrow” or “down arrow”.

Pushing down the encoder corresponds to pressing the software key “Enter”.

The information is presented on a four-line lighted LC-display.

In the first line, the operational conditions of the humidifier are indicated, also see Section „Operational Conditions“.

If the humidifier malfunctions, the red LED in the warning triangle blinks. The humidifier is automatically turned off and a follow-up fault message appears on the display, also see Section: “Malfunctions and Messages / Conditions”.

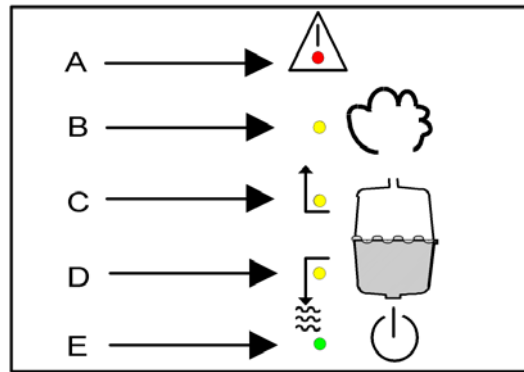

- A: Malfunction (red LED)
- B: humidifying (yellow LED)
- C: Filling (yellow LED)
- D: Blow-down (yellow LED)
- E: Stand-by (green LED)

When the maintenance interval is expired, the green LED blinks and “service” appears on the display. The maintenance interval can be adjusted to the existing feed water quality. For this see “maintenance interval setting.”

Other messages and functions are accessed by using the keys.



Note: As soon as a key is pressed, the display lights up. After one minute without a key being touched, the control switches the display to stand-by mode (dark).

5.1.2 Controls Comfort and Comfort - Plus

The Comfort / Comfort Plus can be programmed for the following control types. To do this set Parameter **Operating Mode** (U6), also see Section „Adjustment of Control to the Control Signal“.

Controls for Comfort / Comfort Plus
1 Step Control
Proportional control with an external controller
Proportional control with integrated software controller

To adjust the Comfort to the signal from the external controller or sensor, set the Parameter **Input Signal** (E3), also see Section „Adjustment of Control to the Control Signal“. ff.

External signals for Comfort / Comfort Plus (E3)	
0(2) - 5 V DC	min. 0,1 mA**
0(2) - 10 V DC	min. 0,2 mA**
0(4) - 20 V DC	min. 0,3 mA**
0(2) - 10 mA DC	min. 1,8 V**
0(4) - 20 mA DC	min. 3 V**
0 - 140 Ohm*	

*Only for Operating Mode (U6): external controller

** Minimum output of control signal.

The steam humidifier normally switches to “no demand” mode with a (control) signal of less than 20%, i.e. no steam is produced. With a minimum signal of 20%, the humidification output is 5% of the maximum output of humidifiers of the HeaterLine type, but 10% of the maximum output of electrode steam humidifiers (HyLine, CompactLine, MiniSteam). Below that level, the unit turns off.

At lower levels of steam output, the steam accumulates in the cylinder or steam hose as condensate, failing to reach its intended location.

5.1.3 Manual Flush

To drain the steam cylinder manually, follow the steps below:

press  and  for longer than 5 seconds.

5.2 Signal Relay PCB (Optional)



Note: This option is not available for electrode steam humidifiers type C01 and C02!

Four additional signal relays are available with the optional signal relay PCB. The possible programmable states for each relay are:

0= collective fault

1= fault data exchange

2= humidification

3= stand-by

4= max.-level (HL and DL humidifiers only)

5= blow-down fault

6= Maintenance interval exceeded

7= fault filling

8= no demand

10= dehumidification [E18]

11= thermo sensor activated [Fault F2] (HL and DL only)

12= fault main cont.

17= Super Flush

18 = maintenance (electrode steam humidifiers only)

*Only with control type “proportional control with integrated software controller”

Connections 31 to 42 are located on the signal relay PCB. The assignments are as follows:

Signal Relay / Contact	Contacts	Parameter for Selecting Switching Signal	Factory Setting for Switching Signal
1. Signal Relay	31, 32, 33	E6	Humidification
Normally Closed Contact	32		
Normally Open Contact	33		
2. Signal Relay	34, 35, 36	E7	Stand-by
Normally Closed Contact	35		
Normally Open Contact	36		

Signal Relay / Contact	Contacts	Parameter for Selecting Switching Signal	Factory Setting for Switching Signal
3. Signal Relay Normally Closed Contact Normally Open Contact	37, 38, 39 38 39	E8	Dehumidify
4. Signal Relay Normally Closed Contact Normally Open Contact	40, 41, 42 41 42	E9	Super Flush

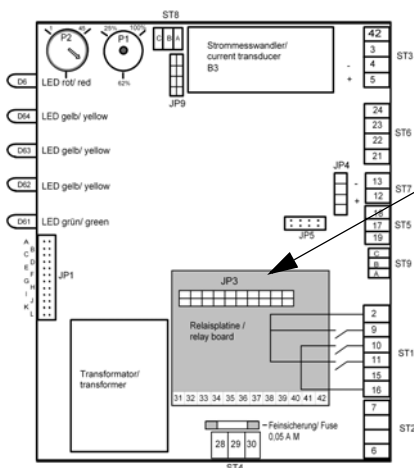

5.2.1 Refitting of Signal Relay PCB:

Place the socket connector JP1 of the relay signal PCB into the socket base JP3 on the main PCB, so that the two bolts on the signal relay PCB line up with the holes (main PCB side).

6. Operational Conditions (dependent on unit type)

The display shows the following operational conditions:

Unit Type	
HyLine, CompactLine, MiniSteam	HeaterLine, HeaterCompact
- Humidifying / Heating up	- Humidifying / Heating up
- Stand-by	- Stand-by
- No demand	- No demand
- Filling	- Filling
- Partial blow-down	- Partial blow-down
- Stand-by draining	- Stand-by draining
- Dilution	
- Full blow-down	
- Power surge - blow-down	- Full blow-down

Humidifying / Heating Up

The steam humidifier produces steam if a demand from the hygostat or controller is present (safety interlock must be closed).

After a humidifier cold start-up, or after a full blow-down, **Heating up** displays for a short time. The display reads **Humidifying** only after the first refill.

Stand-by

The safety interlock is open. The unit is producing no steam.

No Demand

The demand value from the controller is less than the activation point of the steam humidifier. The unit produces no steam.

Filling

The control activates the inlet solenoid valve. The cylinder is supplied with water.

Stand-by Draining

If the controller or hygostat demands no humidity from the humidifier for a long while, a complete blow-down occurs automatically after a set period of time. This prevents standing water in the cylinder. The display shows blow-down. The time period is set at the Parameter Stand-by Draining (A4).

Partial Blow-Down

In order to dilute the concentration of the cylinder water, the control performs regular partial blow-downs.

Complete Blow-Down

Depending on water quality, a complete blow-down is done every 3-8 days.

Power Surge - Blow-Down

At cold start-up, the nominal current increases to a maximum of 128% in order to achieve a rapid start-up. When this current value is reached, a **power surge blow-down** is triggered and performs partial drainage of the cylinder.

Dilution

The **Dilution** message is displayed if an additional partial blow-down is required. This occurs for example at high conductivity levels, with a significantly fluctuating control signal, or when drainage is blocked.

6.1 Fault Messages (Comfort / Comfort Plus - Control)

The Comfort / Comfort Plus - Control continuously monitors all important functions of the steam humidifier. If the control detects a fault, it turns off the steam generator.

To signal a fault, the red LED on the operation and display unit blinks and a message appears on the display.

Fault Name		Unit Type	
		HyLine, CompactLine, MiniSteam	HeaterLine, Heater- Compact
Blow-down fault	F1	x	x
Thermo sensor activated	F2		x
Max.-level	F3		x
Fault filling	F4	x	x
RH Sensor fault	F6	x	x
Fault Sensor	F7		x
Maintenance	F8	x	
Steam-down time	F8		x
Fault main cont.	F10	x	x
System Failure	F9	x	x
Lost Ground Control		x	x

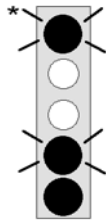

Blow-Down Fault

The control periodically activates the blow-down pump. If no water or insufficient water is flushed out during the blow-down process, the control signals a „**blow-down fault**“.

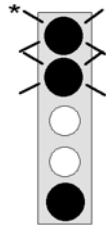

Thermo Sensor Activated

If a thermo sensor is activated, the control indicates this as a „**thermo sensor activated**“ fault.

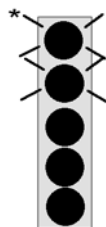

Max.-Level

If the water level in the cylinder reaches max.-level five times within a five-hour period, the control signals a „**Max.-Level**“ fault. In cases when the unit has been turned off during this period, or when no humidity demand is present, the control resets the internal counter.

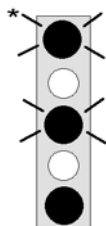

Filling Fault

At the standard setting, the control activates the solenoid valve for a maximum of 30 minutes. During this period the water level in the cylinder must reach a specific point. If this is not the case, the control detects a „**Filling Fault**“.

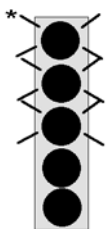

RH Sensor Fault

If the humidity sensor signal is less than 3% RH (interruption in output), the control signals a „**RH Sensor Fault**“.

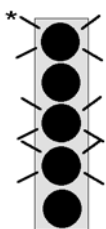

Fehler Sensor Fault

The level control is equipped with two float switches and three dry reed contacts. If the float or dry reed switches are triggered in the wrong order, the display shows a „**sensor fault**“.

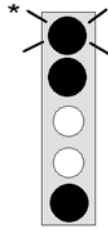

Steam-Down Time Exceeded

The control activates the inlet solenoid valve at time intervals when humidification is required. If the control has not activated the solenoid valve in many hours despite constant demand for humidification, the fault „**Steam-down time exceeded**“ appears on the display.

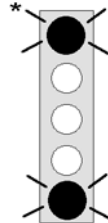

Maintenance

The control also turns the humidity generator off after one hour of operation with a full cylinder. The display reads „**Maintenance**“. In most cases, maintenance must be done on the cylinder..

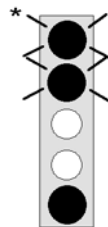

Main Contactor Fault

The control switches on the main contactor when demand for humidification is present and the safety interlock is closed.

The control switches off the main contactor if the safety interlock opens or if demand is no longer present.

If the control detects no current for at least 15 seconds, even though the main contactor should be activated, the control signals „**fault main cont.**“.

The maximum water level message only displays if the main contactor is switched on, i.e. when demand is present and the safety interlock is closed. If the control registers maximum water level for longer than 15 seconds, even though the safety interlock is open or no demand is present, the control signals “**fault main cont.**”.

* Captions, also see Section „Malfunctions“.

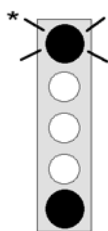

System failure

Mainboard is defective.

Lost Ground Control

Communication between main board and display is disturbed.

7. Software Menu and Parameter Setting

Local communication (data entry and readout) is possible with the Comfort Control using the display and the keypad.

The most important types of communication are:

- Readout of important operational conditions
- Selection of the active language (in Menu Mode)
- Readout of humidifier type data (“electronic name plate”; in Menu Mode)
- Selection/Modification of essential parameters and system functions (in Menu Mode)

Access Options:



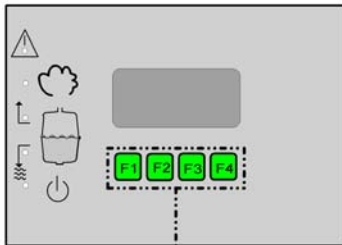

Some parameters can be directly changed (direct change to desired values); other parameters and system functions appear in submenus. Parameters and system functions which have a critical impact on the proper operation of the humidifier are typically protected by an access procedure that requires entry of a code (P0=010).



The sections below describe the configuration of the software menu, navigation through the menus, as well as display values, parameters and system functions.

Function of Keys F1 to F4

Keys F1 to F4 are located below the display. Above each key, a context-based action (software key) is shown on the lowest line of the display (i.e. an “up arrow” key). The action is performed by pressing the key. The software keys in the display unit enable menu navigation and parameter modification as indicated below:

Software Key Function	
	Access Menu Mode
	Back to previous menu level
	Reduce a value or “scroll up” within a menu or parameter list
	Increase a value or “scroll down” within a menu or parameter list
	Save or confirm a value / a figure or navigate to the subordinate submenu

7.1 Menu Configuration

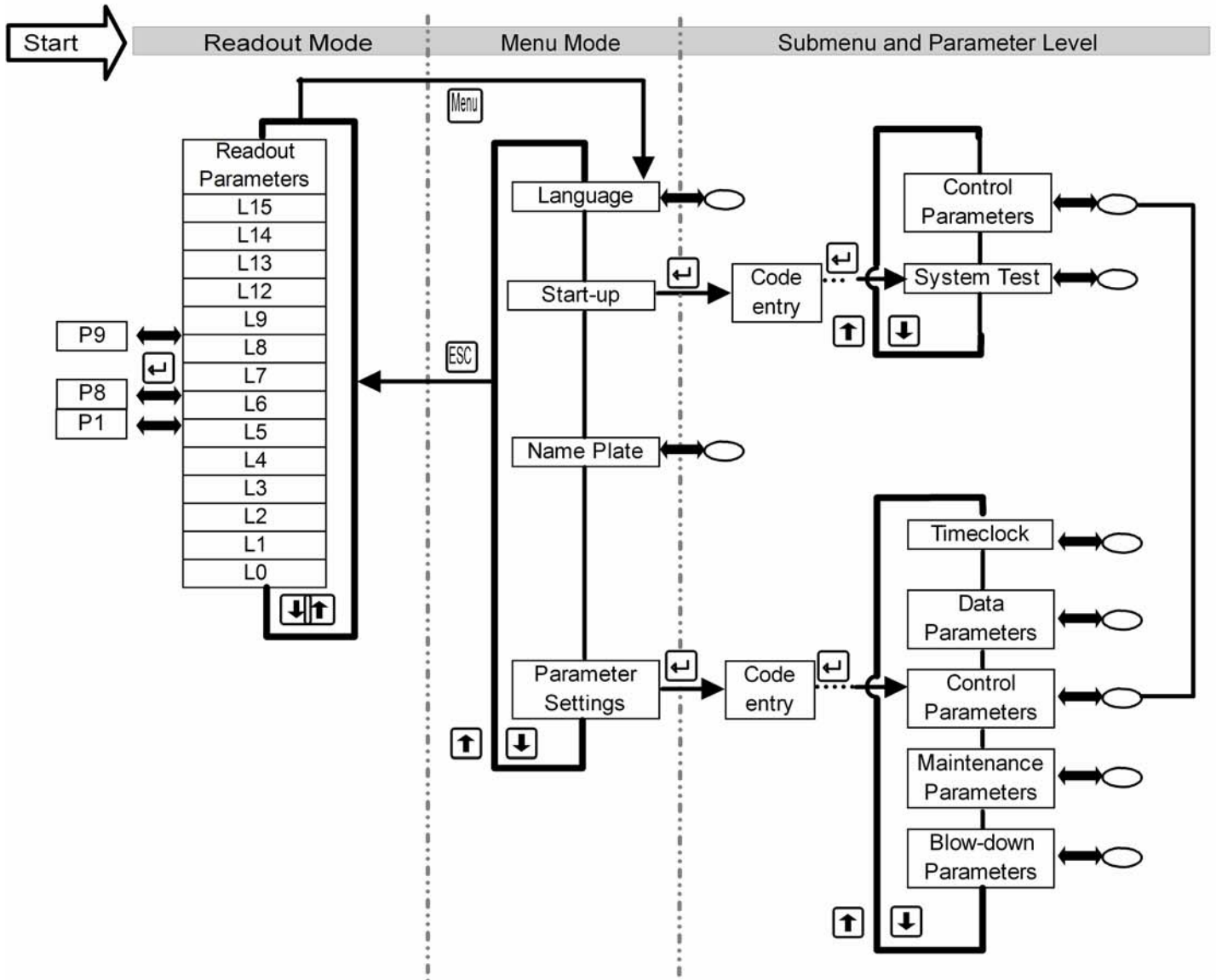

Explanation:



Toggle between Menu and Submenu



↔ indicates transition to the next Submenu

[Right Arrow] [ESC] ... : are software keys in the control's display. They can be activated by pressing the keys below them.

7.2 Readout Mode

Using  or , you can toggle between the readout values (L x) below:

Readout	
L15	K1 (main contactor) operation cycles
L14	Y1 (solenoid valve) operation cycles
L13	Operating hours counter [dddd:hh]
L12	Output signal [%]
L7*	Actual value relative humidity [% RH]
L6*	Desired value relative humidity [% RH]
L5	steam generation output limitation [%max.output]
L4	Demand [%]
L3	Internal control signal [%max.output]
L2	actual current value [A]
L1	steam output [kg/h]
L0	total steam [10 ³ kg]

*Only when PI software controller is activated.



Note: Normally the display shows the operational conditions of the humidifier and a readout value. The readout value is selected as in the example below:

Example: The standard display should show the “actual value relative humidity” (L7):

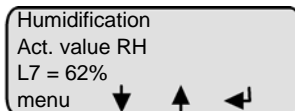

- » With  or  select the actual relative humidity value
- » Confirm selection with 

7.2.1 Direct Entry of a Desired Value in Readout Mode

In readout mode, readout values can be displayed but not modified. Access with modification is possible for frequently adjusted values.



L5	steam generation output limitation
L6*	desired value relative humidity

* Only when using an PI-controller



Note: If the unit is turned off, modifications to desired values in readout mode are lost.

Example: The steam generation output limitation value should be reduced from 100% to 50%:

press  or  until Readout Parameter L5 appears on the display

Filling
Output limit.
L5: 100%
menu ↓ ↑ ↵

» press 

Output
limitation
P1: 100
menu ↓ ↑ ↵

» press 

Output
limitation
P1: 000
menu ↓ ↑ ↵

» press 

Output
limitation
P1: 000
menu ↓ ↑ ↵

» press  five times

Output
limitation
P1: 050
menu ↓ ↑ ↵

» press 

Output
limitation
P1: 050
menu ↓ ↑ ↵

» press 

Filling
Output limit.
L5: 50%
menu ↓ ↑ ↵

7.3 Menu Mode

In Menu Mode, you have access to the following menus:

- Language
- Start-Up
- Name Plate
- Parameter Settings

7.3.1 Language Menu

In this menu, you can select the language in which you communicate with the humidifier.

Sprache / Language
Italian
Japanese
Spanish
French
English
German

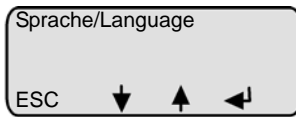

Programming sequence to modify the language:

press 

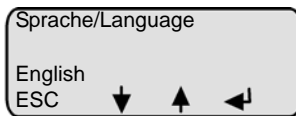

press 



select the desired language with  or 

confirm with 

Exit the language menu with 



Note: Changes to the language are saved even when the unit is turned off.

7.3.2 Start-Up Parameters Menu

The start-up menu comprises settings and parameters that may be needed for humidifier start-up.

Navigation to the submenu “start-up parameters” is protected from unauthorized access by an access code request. The access code is “010”.

The start-up menu is divided into four submenus.

- System Test
- Control Parameters

7.3.2.1 Control Parameters Submenu

Parameters for adjusting to the control signal, and related control characteristics, as well as for steam generation output limitation, are located in this submenu.

Summary of parameters:

Parameter	Description	Possible Settings	Access Code
P1	Steam generation output limiter [%]	[25-100%]	010
E1*	Xp-PI-controller =100/E1 [Amplification]	[0- 100]	010
E2*	Tn-PI-controller [Integration time]	[0- 255sec.]	010

Parameter	Description	Possible Settings	Access Code
E3	Input signal	0(2)-5 VDC 0(2)-10 V DC 0(4)-20 V DC 0(4)-10 mA DC 0(4)-20 mA DC 0-140 Ohm	010
E4*	adjustment value humidity sensor	[+/-15%]	
E18*	Offset Dehumidifier	[-2 to +15%]	010
P4	Offset control signal	[0-100%]	010
P7*	sensor damping	[yes/no]	010
P8*	Desired value relative humidity	[% RH]	010
U6	Controls	1-step (On/Off) PI-control Ext. control Master Sign.** Int. PI + max.*	010

* Only when PI-controller is activated

** Only for controlsignal from Masterunit via interface.

7.3.2.2 System Test Submenu



This test enables checks of various humidifier functions (for example, during start-up).

The following test routines can be executed:

System Test
Automatic System Test (includes all stand-alone tests)
LED Test (stand-alone test)
Pump/MV test (stand-alone test)
Control Status Test (stand-alone test)

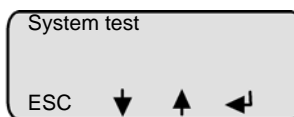
To select the “System Test” submenu (the initial programming sequence here is analogous to the description of navigation to the control parameters submenu):



- » select the desired test routine with  or  and confirm with  - the test will be executed

Automatic System Test

The automatic system test performs all the stand-alone tests described below. Upon completion of each test, a message appears on the display. After this, press „next“ to proceed to the next test. After the last test the humidifier resets when pressing „next“.

LED Test

This test provides the ability to check the function of the LEDs. The LEDs **Humidifying**, **Filling**, **Blow-Down**, **Steam Production** and **Fault** are activated sequentially for a few seconds. Simultaneously, the component which corresponds to the LED is activated. For example, the water inlet solenoid valve is activated along with the LED Filling, or the collective fault relay is activated when the LED Fault is activated. Pressing „next“ leads to a reset of the humidifier.

Pump/MV Test

This test checks the function of the inlet solenoid valve and blow-down pump by filling or partially draining the cylinder. The following messages can be displayed:

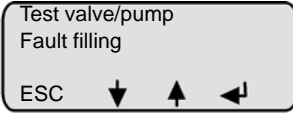
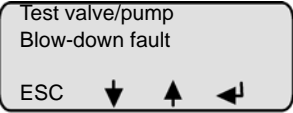
Sample Display	Status
	Solenoid valve out of order; also see Section „Malfunction“, Filling Fault.
	Blow-down pump out of order; also see Section „Malfunction“, Blow-down fault

Pressing „next“ leads to a reset of the humidifier.



Note: This test can take up to 30 minutes.



Note: The safety chain must be closed for this test.

Control Status Test

This test checks the signals to terminals 1+2 and 4+5 against U6, also see Section „Malfunction“.

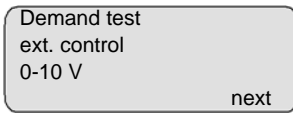
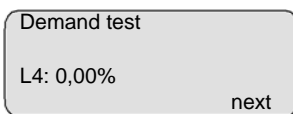
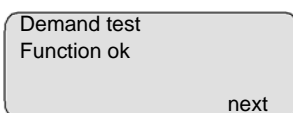
Sample Display	Function
	The setting of the control signal is displayed. ↓ (next)
	The status of the control signal is displayed ↓ (next)
	Pressing „next“ leads to a reset of the humidifier.

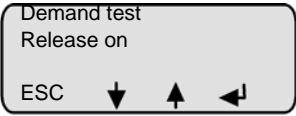
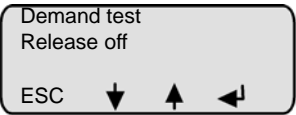
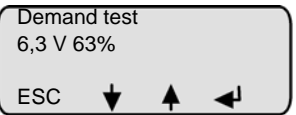
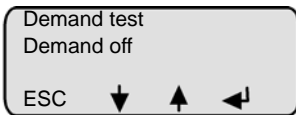
Sample Display	Status
	Safety interlock is closed. Humidifier operates with 1 step control.
	Safety interlock activated (i.e. by Max.-Hygrostat). Humidifier is on stand-by.
	Safety interlock is closed. No demand is present. The demand percentage is displayed. The humidifier is operating.
	No demand from the controller. The humidifier is on stand-by.





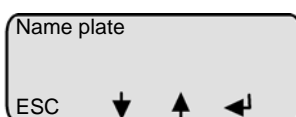
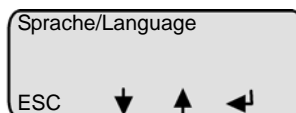

* Only for control types (U6): external controller, PI-controller

7.3.3 Electronic Name Plate Menu

The following unit-specific information can be displayed:

Electronic Name Plate	
S1	Cylinder number
S2	Nominal output [kg/h]
S3	Software version
S4	Unit type
S5	Year of manufacture
S6	Serial number
S10	Equipment designation



- » press 
- » press  or  until "name plate" appears on the display
- » press  and then press  or  until the desired value appears on the display

7.3.4 Parameter Setting Menu

Parameters partly determine the humidifier's sequence of operations and processing of signals.

These parameters can be modified as needed.

For security reasons, access to some parameters is protected by an entry code. Two separate access levels have been defined:

Access Code 010

- Basic customer level" without access code
- Advanced customer level" with access code "010"

The "Parameter Setting" menu is divided into five submenus:

- Maintenance Parameters
- Control Parameters
- Blow-Down Parameters
- Time Clock
- Data Parameters

If access to the "Parameter Settings" menu is gained by entering access code "010," an expanded set of parameters is available compared to access without a code entry.

The pages below provide a summary table of parameters containing the following:

- parameter designation
- possible parameter value settings
- Menu/submenu where the parameter is located
- required access code for the parameter

At the end of the summary table, the parameters are described in detail; examples of programming sequences for parameter setting are provided with and without access codes.

7.3.4.1 Summary Table of Parameters

Parameter	Designation	Possible Settings	in Menu/Submenu	Access Code
A4	Stand-by Blow-down	0 min to 999 hours hhh : mm	Parameter Settings/ Blow-down parameters	none
E1*	Xp-PI-controller = 100/ E1 [Amplification]	0 - 100	Parameter SettingsControl Parameters	010
E2*	Tn-PI-Controller [Integration time]	0 - 255 sec.	Parameter SettingsControl Parameters	010
A17	Stand-By heating	No/Yes	Start-up/System settings	010
C16	Interval time A17	0 - 999 min.	Settings/Power Parameter	010
C17	On time A17	0 - 255 sec.	Settings/Power Parameter	010
E3***	Input signal(limit values adjustable at P4)	0(2)-5 VDC 0(2)-10 V DC 0(4)-20 V DC 0(4)-10 mA DC 0(4)-20 mA DC 0-140 Ohm	Parameter Settings/ Control Parameters	010
E4*	adjustment value humidity sensor	+/- 15%	Parameter Settings/ Control Parameters	none
E5	base relay (programmed switching signal)	0 = collective fault (Factory Setting) 1=fault data exchange 2=humidification 3=stand-by 4=max.-level 5=fault blow-down 6=service7=fault filling 8=no demand 10=dehumidification [E18] 11=activated thermo sensor 12=fault K1 main contactor 17=Super Flush 18=maintenance	Parameter Settings/ Data Parameters	010

* Only if PI-controller is activated

** Only if optional signal relay PCB is mounted

Parameter	Designation	Possible Settings	in Menu/Submenu	Access Code
E6**	1. signal relay	same options as with E5, status 2 = factory set	Parameter Settings/Data Parameters	010
E7**	2. signal relay	same options as with E5, status 3 = factory set	Parameter Settings/Data Parameters	010
E8**	3. signal relay	same options as with E5, status 10 = factory set	Parameter Settings/Data Parameters	010
E9**	4. signal relay	same options as with E5, status 17 = factory set	Parameter Settings/Data Parameters	010
E17	baud rate interface	9600 / 4800 / 2400 / 1200	Parameter Settings/Data Parameters	010
E18*	offset dehumidifier	[-2 to + 15%]	Parameter Settings/Control Parameters	010
H1	blow-down counter (partial blow-down)	0 - 255 (filling cycle) only for Electrode Steam Humidifier	Parameter Settings/Blow-Down Parameters	
H2	blow-down duration (partial blow-down)	0-255 [s] only for Electrode Steam Humidifier	Parameter Settings/Blow-Down Parameters	010
H6	full blow-down	Yes (On) No (Off)	Parameter Settings/Blow-Down Parameters	010
H11	blow-down counter (partial blow-down)	0 - 999 kg only for HeaterLine unit	Parameter Settings/Blow-Down Parameters	010
H12	blow-down duration (partial blow-down)	0-255 [s] only for HeaterLine unit	Parameter Settings/Blow-Down Parameters	010
P1	steam generation output limitation	25% to 100%	Parameter Settings/Control Parameters	none
P2	quantity of steam maintenance interval	0.1 to 25.5 [10 ³ kg]	Parameter Settings/Maintenance Parameters	010
P3	reset maintenance interval	Yes / No	Parameter Settings/Maintenance Parameters	010
P4	offset control signal	0 to 100%	Parameter Settings/Control Parameters	010
P5	address	1 - 999	Parameter Settings/ Data Parameters	none
P7*	sensor damping	Yes/No	Parameter Settings/ Control Parameters	none
P8*	desired value relative humidity	[% RH]	Parameter Settings/ Control Parameters	010
P11	reset main contactor interval	Yes / No	Parameter Settings/Maintenance Parameters	010

* Only if PI-controller is activated

** Only if optional signal relay PCB is installed

Parameter	Designation	Possible Settings	in Menu/Submenu	Access Code
T0	time clock (only for Comfort Plus)	Switch on and switch off times (weekly, daily)	Parameter Settings/ Time Clock	none
U5	main contactor switched off during blow-down	ON (main contactor=off) OFF (main contactor=on)	Parameter Settings Blow-Down Parameters	010
U6	controls	1-step external controller PI controller	Parameter Settings Control Parameters	010

* Only if PI-controller is activated

** Only if optional signal relay PCB is installed

7.4 Description of Parameters

A4 Stand-By Blow-Down

(If the controller or hygrostat demands no humidity from the humidifier for a long period of time (factory setting: 24 hours), it is advisable to flush out the cylinder water. At Parameter A4 Stand-By Blow-Down, the time period is set after which the complete blow-down is automatically performed. Water will not be fed into the cylinder until a new demand signal is received. Werkseinstellung: A4=24 Std.).

A17 Stand-by heating

The stand-by heating keeps the cylinder water warm when no request is pending. The heating takes place if the safety chain is closed at intervals according to parameter C16 for the heating time according to parameter C17.

C16 Interval time A17

The C16 parameter defines the length of the pause time between the phases of the stand-by heating (active only if A17 = Yes).

C17 On time A17

The C17 parameter defines the length of the heating period for the stand-by heating (active only if A17 = Yes.)

E1 Xp-PI-Controller

Boosting PI-controller ($Xp = 100/E1$) [%]

E2 Tn-PI-Controller

Reset Time PI-controller [$Tn = 0 - 255$ sec]

E3 Input Signal

To adjust the Comfort / Comfort Plus Control to a signal from an external controller (U6= external controller), set Parameter E3, also see Section: „Parameter Setting with Codes (P0=010) / Advances Customer Level“. Similarly, set Parameter E3 to the signal from the active humidity sensor when using an internal PI-controller.

E4 Adjustment Value Humidity Sensor

Using this parameter, you can calibrate the active humidity sensor at terminals 3-5 in a range from -15% RH to +15% RH.

E5 Base Relay

The base relay provides a potentialfree two-way contact at terminals 28, 29 and 30 (rated load: 250V/8A).

It is activated if certain operational conditions apply. The operational condition "collective fault" is preset.

It is possible to associate another operational condition with the base relay circuit, also see Section: "Summary Table of Parameters" on Page 56, "Parameter E5."

E6 1. Signal Relay

If the optional signal relay PCB is employed, additional two-way relay outputs are available whose switching functions can be programmed in the same way using Parameter E5. Parameter E6 is responsible for the switching function of the first additional signal relay.

E7 2. Signal Relay

This setting corresponds with the description of Parameter E6. Parameter E7 is responsible for the switching function of the second additional signal relay.

E8 3. Signal Relay

This setting corresponds with the description of Parameter E6. Parameter E8 is responsible for the switching function of the third additional signal relay.

E9 4. Signal Relay

This setting corresponds with the description of Parameter E6. Parameter E9 is responsible for the switching function of the fourth additional signal relay.

E17 Baud Rate Interface

As an option, the Comfort / Comfort Plus can be supplied with an RS485 or RS 232 computer interface. Here one can set the baud rate required for data transfer.

E18 Offset Dehumidifier

Parameter E18 Offset Dehumidifier specifies the dead band between humidification and dehumidification. The standard programmed setting for Parameter E18 is +5%.

The potentialfree output (terminals 28, 29, 30) can be used for 1 step control of a dehumidifier. In this case, Parameter U6 Controls must be set to operation mode "PI-controller".



To use this function, the base relay or one of the optional signal relays must be programmed for the function "dehumidification" and the dehumidifier must be connected to this relay.

The switchover point between humidification and dehumidification is specified using parameters P8 desired value rel. humidity

and E18 offset dehumidifier. The hysteresis of 1% cannot be modified.

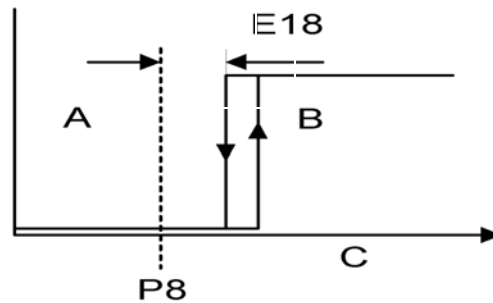

A: Humidification
B: Dehumidification
C: Rel. Humidity RH %

Example:

P8 desired value rel. humidity = 50%

E18 offset dehumidifier = 5%

switchover point humidification-dehumidification =
55% + 1% hysteresis

In this example, the dehumidifier switches on at 56% RH and off at 55% RH.

H1 Blow-Down Counter (only for electrode humidifiers)

Using this parameter, one specifies how many solenoid valve utilizations occur before a partial blow-down is performed. The preset value should only be modified in consultation with Hygro-Matik.

H2 Blow-Down Duration (only for electrode humidifiers)

Using this parameter, set the pump run time during partial blow-down. This is given as a specific blow-down time in seconds.

H6 Blow-Down

With this parameter, you turn the full blow-down function on and off. The setting "blow-down yes" means that blow-down is switched on.

H11 Blow-Down Counter (only for HeaterLine Type humidifiers)

Using this parameter, you specify the quantity of steam. After the steam humidifier has produced this quantity of steam, the control initiates a partial blow-down. The preset value should only be modified in consultation with HygroMatik.

H12 Blow-Down Duration (only for HeaterLine Type humidifiers)

With this parameter, you set the pump run time during partial blow-down. This is given as a specified blow-down time in seconds. The preset value should only be modified in consultation with HygroMatik.

P1 Steam Generation Output Limitation

The steam output can be set to a value between 25% and 100% of nominal output using the steam generation output limitation. The actual steam output released depends on the control signal. Limitation of the steam output may be needed for better control.









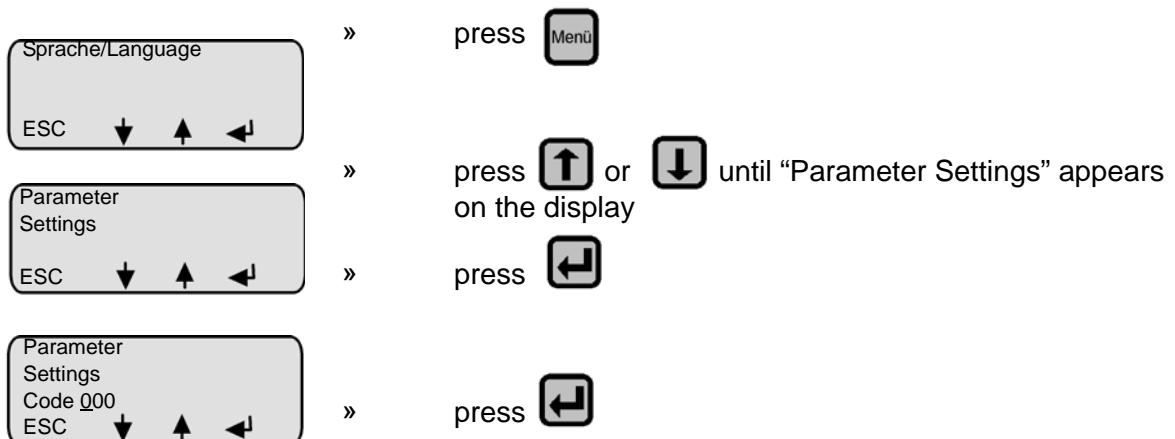



P2 Quantity of Steam Service Interval

The Comfort / Comfort Plus Control records the quantity of steam actually produced. The quantity of steam service interval is saved in Parameter P2 Steam Amount Service Interval. If the humidifier has produced this quantity of steam, the green LED on the operation unit blinks continuously (service message). The frequency of maintenance depends primarily on the water quality (conductivity, carbonate deposits) and on the interim steam amount produced. The maintenance interval can be adjusted to the water quality using Parameter P2.

P3 Reset Service Interval

After maintenance, reset the service interval as shown below (green LED is still blinking):



Parameter Settings Code 000 ESC ↓ ↑ ←	»	press 
Parameter Settings Code 010 ESC ↓ ↑ ←	»	press 
Parameter Settings Code 010 ESC ↓ ↑ ←	»	press 
Control Parameter ESC ↓ ↑ ←	»	press  and 
Maintenance interval P2: 3.00 ESC ↓ ↑ ←	»	press 
Reset maintenance Interval P3: no ESC ↓ ↑ ←	»	press 
Reset maintenance Interval P3: no ESC ↓ ↑ ←	»	press 
Reset maintenance Interval P3: Yes ESC ↓ ↑ ←	»	press 
Reset maintenance Interval P3: No ESC ↓ ↑ ←	»	press 
Maintenance Parameter ESC ↓ ↑ ←	»	press  to exit the submenu
Confirm changes with ENTER ↓ ↑ ← yes	»	the modification must be confirmed to be saved permanently; to do this press 
Parameter Settings ESC ↓ ↑ ←	»	press  to exit the menu
Stand-by Steam kg/h L0: 5:00 ESC ↓ ↑ ←		

P4 Offset Input Signal

Comfort / Comfort Plus controls are typically connected to a humidity sensor, whose signal of 0 V, 0 mA or 0 Ohm indicates 0% RH. If you employ another humidity sensor, i.e. a humidity sensor with an input signal of 4-20 mA, the Parameter P4 “offset input signal” must be programmed to 20%. Taking this step ensures that the Comfort / Comfort Plus control correctly reads a 4 mA signal as 0% RH.

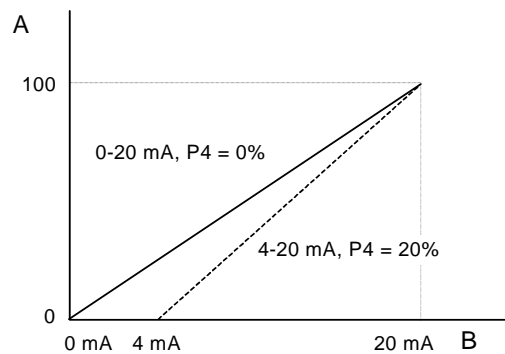

A: Humidity [% RH]

B: Input Signal Humidity Sensor

The same applies for an external control signal of 2-10 V, 4-20 mA, 2 - 5 V or 4 -10 mA.

P5 Address

As an option, the Comfort / Comfort Plus can be equipped with an RS485 or RS232 computer interface. The required Modbus RTU address for this can be set here.

Sensor Damping (P7)

This parameter affects the response behavior of the internal software controller. The setting “sensor damping yes” activates a damping element. This is advisable when connecting the control to a delay action capacitive humidity sensor.

P8 Desired Value Relative Humidity

At Parameter P8, one can set the desired value for relative humidity [%]. This parameter is only displayed if the control is set to “PI-controller” (U6=PI-controller).

P11 Reset main contactor interval

After the preprogrammed number of operations of the main contactor (K1) the HygroMatik control provides the message "Maintenance K1". It is recommended to swap the main contactor and to put the message back. The programming sequence is done in a manner similar to the parameter "P3 Reset Service Interval".

7.4.1 T0 Time Clock



(available only with Comfort Plus Control)

If the Timer Mode T0 is programmed to a daily or weekly period of operation and the external safety chain is closed the steam generator is released during the programmed periods.

Setting the system time and date:

For commissioning and after changing the battery the current system time and date has to be set.

By pressing  in the time clock menu the system time is displayed.

Pressing  again allows to change the system time with  or .

Confirm entry with .

Afterwards the current system date can be displayed by pressing .





Changing the system date corresponds to the operating sequence for the system time.

Setting the Timer Mode

There are three possible settings for the time clock:

- **off:** time clock is disabled
- **weekly:** every day the steam generator is released for the same period of time
- **daily:** for each weekday the steam generator is released for a special period of time

The setting:

Within the submenu „Time Clock“ press  until „Timer Mode“ appears. Select the „Timer Mode“ submenu by pressing  and choose between the three possible settings with . By pressing  the chosen setting is stored. If a daily or weekly timer mode is chosen press  for putting in the respective switch-on and switch-off times [hh:mm] (T1 and T2 = weekly operating period; T3 and T16 daily operating period).

U5 Main Contactor Switched Off During Blow-Down

With this parameter, one can specify the status of the “On” / “Off” safety contactor. At the “on” setting, the control will switch off the contactor during the blow-down procedure.

This setting could be useful if the power supply line is routed through a sensitive residual-current circuit breaker.

U6 Controls

With parameter U6, one can set the humidifier control type. For an example of the programming sequence used to modify this parameter, see „Parameter Setting with Codes (P0=010) / Advances Customer Level“.

7.5 Computer Interface

As an option, the Comfort / Comfort Plus Control can be equipped with an RS485 or RS232 computer interface. It forms the basis for the Modbus RTU protocol that is integrated in the control software.

RS485:

The optional interface RS485 meets the American Electronics Industry Association (EIA) Standard. Data is transmitted over two cables.

RS485 interface hardware supports connections to a field bus (i.e. Profibus, Bitbus, EIB,...)

The serial interface with 3-pole connector is used for transmission of status messages and operational values.

Operational parameters can be entered and modified using this interface.

The unit can be switched on and off remotely

Built-In Terminal	ST8
Pin Assignment	C TxD
	B RxD
	A Gnd



Note: For information on the Modbus RTU protocol, consult with HygroMatik.















Note: Custom software adapted to interface types is written by the customer.

7.6 Parameter Setting without Codes (P0=000) / Basic Customer Level

Example: The time period after which stand-by blow-down is performed (Parameter A4) should be changed from the factory setting (A4 = 24h min) to A4 = 10 h.

7.6.1 Programming Sequence for Modifying Parameter A4:

- » press  and select menu "Parameter Setting" with  or 
- » press 
- » press 
- » press 
- » press 
- » select submenu "Blow-Down Parameter" with  or 
- » press  (= enter the menu)
- » press  (=select parameter to be modified)
- » the cursor is positioned under the 1st digit. Press  twice.
- » the cursor is positioned under the 3rd digit. Press 

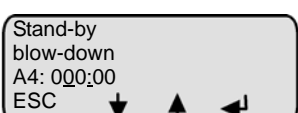
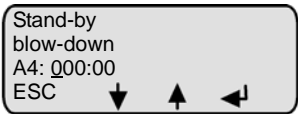
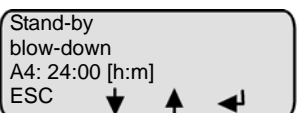
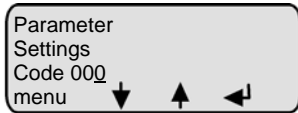
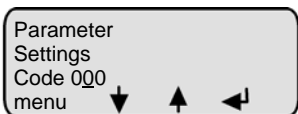
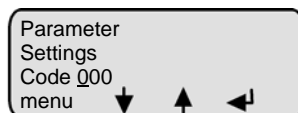
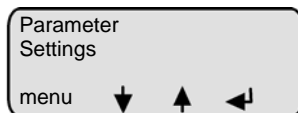



»

twice to modify the value and confirm with

the cursor is positioned under the 4th digit. Press

4 times to modify the value and confirm with



»

exit the field with



»

exit the submenu with

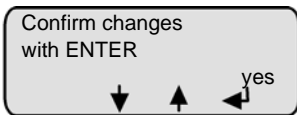

»

the modification must be confirmed to be saved permanently; to do this press



»

exit the menu with

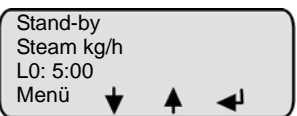

»

the parameter modification will be permanently saved.

With return to readout mode (= lowest level)

7.7 Parameter Setting with Codes (P0=010) / Advanced Customer Level









Example: The control signal setting should be adjusted.

The factory setting is a 0-10V signal from an external controller; this setting should be changed to activate the PI-controller to connect to an active humidity sensor with a 0-20 mA DC signal.









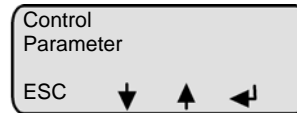
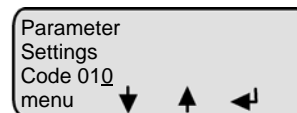
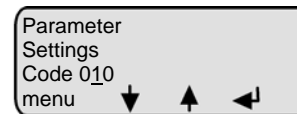
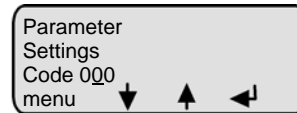
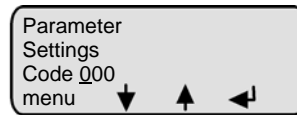
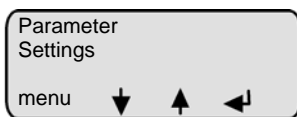

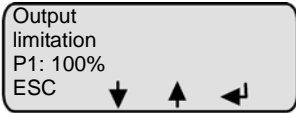

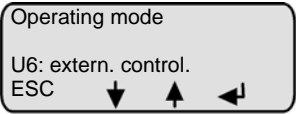

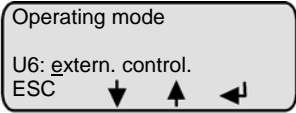

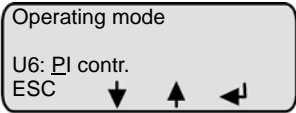
Accordingly, the parameters must be changed as indicated below:

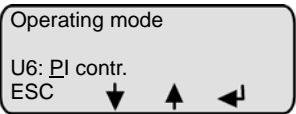
Parameter	Old Value	New Value
U6	external controller	PI-controller
E3	0-10 Volts	0-20 mA

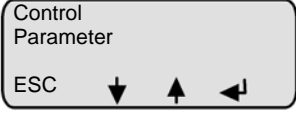
7.7.1 Programming Sequence for Modifying Parameter U6:

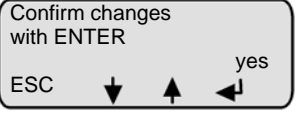
- » press  and select "Parameter Settings" menu with  or 
- » press 
- » the advanced customer level access code (P0=010) must be entered; press 
- » press 
- » press 
- » press 
- » press  (= enter the menu)

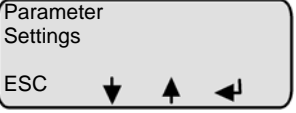

- »  press 
- »  press  (= select the parameter to be modified)
- »  select "PI-controller" with 
- »  confirm with 
- »  exit the submenu with 
- »  exit the menu with  . The parameter change must be confirmed.
- »  confirm with 
- »  the parameter change will be permanently saved. Press  to return to readout mode (= lowest level)
- » 

7.7.2 Programming Parameter E3

Follow the same programming steps used for “Modifying Parameter U6” (previous section), until the “Control Parameters” sub-menu is displayed:



» press  (= enter the menu)

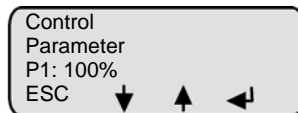

» press  until Parameter E3 is shown

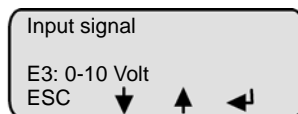

» select Parameter E3 for modification with 

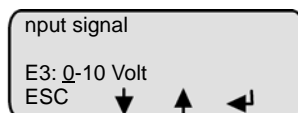

» hold down  until “0-20 mA” appears

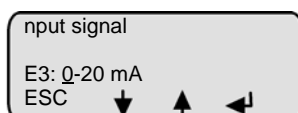

» confirm with 

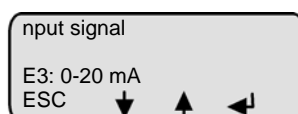

» exit the submenu with 



» exit the menu with  ; the modification must be confirmed to be permanently saved

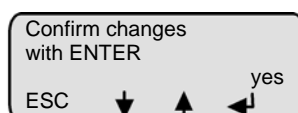

» confirm with 

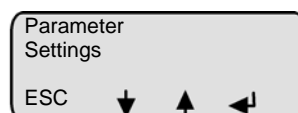

» the parameter change will be permanently saved; use  to return to readout mode (= lowest level)

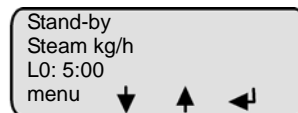

8. Twin Cylinder Units (HyLine 60-116) and Double Units (HeaterLine 60-90)

The humidifiers type HyLine 60-116 are twin cylinder units. Each steam cylinder is supervised by its own control. The external control signal and the safety interlock signal have only to be connected to the terminal block of the first cylinder. The wiring for the signals between terminal block of cylinder one and cylinder two is already done ex works (please also see wiring diagram S-043002).

Schema twin cylinder units HyLine 60-116

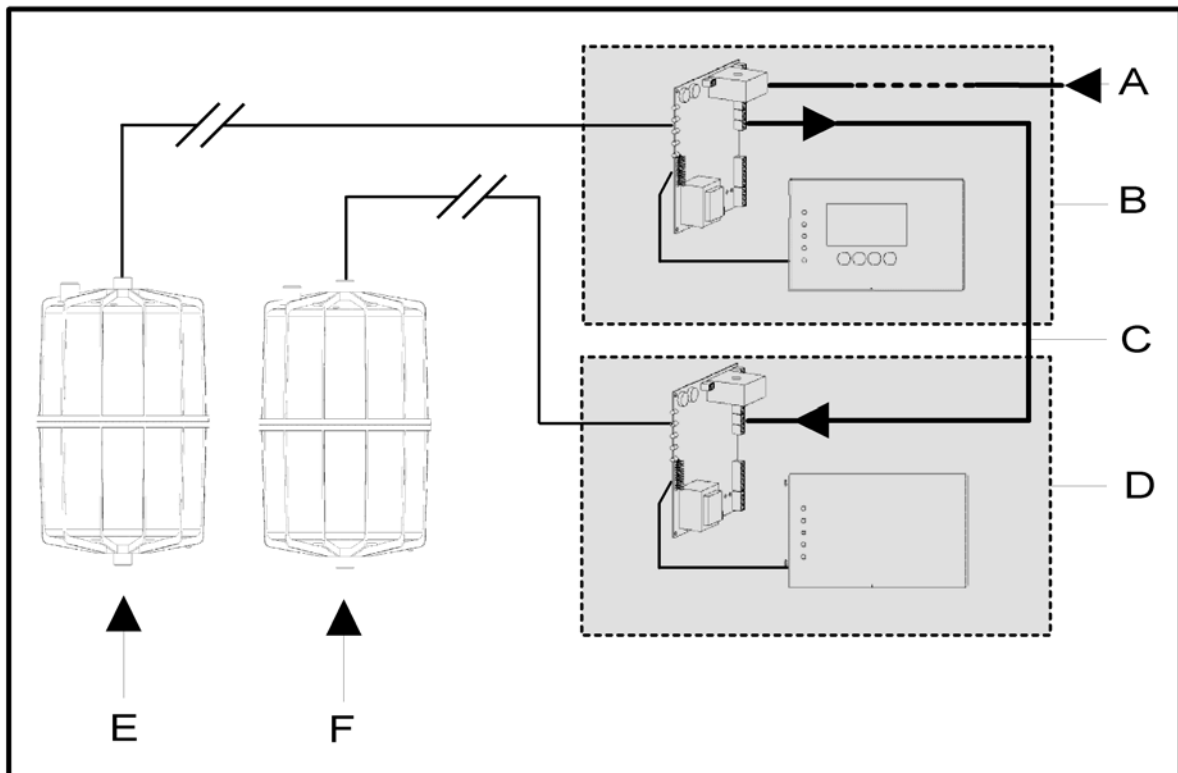

- A: external control signal **and** safety interlock signal
- B: control - first cylinder
- C: internal control signal for control of second cylinder
- D: control - second cylinder
- E: first steam cylinder
- F: second steam cylinder

The heating element humidifiers type **HeaterLine 60-90** are double units - they consist of two separate units. The control signal and the safety interlock signal are connected to the terminal block of the first humidifier (the guidance humidifier). Between the first and the second humidifier there has to be an electrical connection (done by the customer): The second (slave) humidifier receives a control signal and the forwarded (potential free) safety interlock signal from the first humidifier.

The wiring for control signal and safety interlock signal for humidifiers type HL60-90 is done as follows:

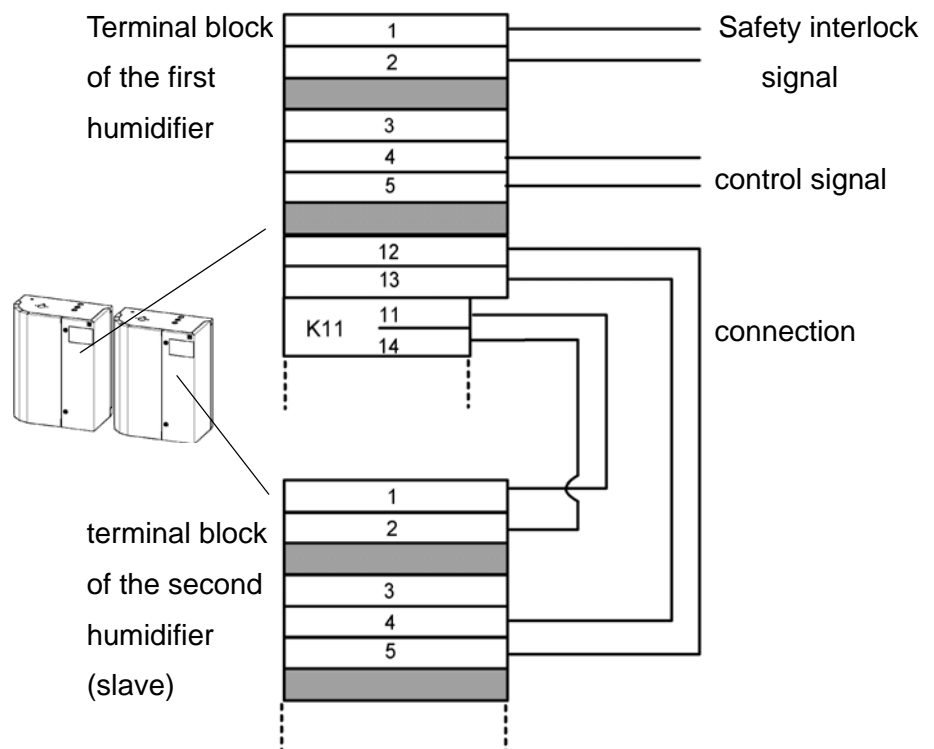

Note: The control of the second humidifier is normally a Basic control consisting of mainboard and display plate with 5 LED. The control of the first humidifier can be a Basic, Comfort or Comfort Plus. To change parameters at the control of the second humidifier please also see chapter „Basic Control“ in this manual. Please note that jumper A, B and C are not set - and this should not be changed.

9. Malfunctions and Messages / Conditions



Warning: Note display message and switch off the unit immediately in case of malfunction. Malfunctions can only be repaired by qualified personnel in accordance with safety instructions.



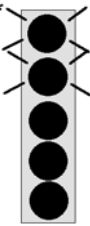
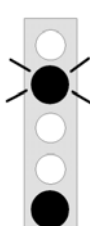
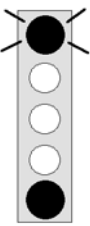

Note: The fault messages displayed depend on the humidifier type in use; “HE” denotes heater element steam humidifiers in the table and “ESH” denotes steam humidifiers. It is possible that certain fault messages will apply to one or both humidifier types.

LED Display	HE *** ESH ***	Message / Malfunction Displayed*	Probable Cause	Resolution
	X X	Blow-Down Fault Unit shuts off automatically	<ul style="list-style-type: none"> Blow-down pump has not been electrically activated <ul style="list-style-type: none"> Cable connections are faulty The relay on the main PCB is not operating Defective blow-down pump Solenoid valve does not close properly. Water level in the cylinder sinks very slowly even though blow-down pump flushes out water. Blow-down pump operates, but no water is pumped out, i.e. the cylinder drain is blocked. Blow-down pump is blocked up with mineral deposits. 	<ul style="list-style-type: none"> Check or replace cable connections Measure voltage at the PCB terminals against N or replace PCB Replace blow-down pump. Check solenoid valve. Thoroughly clean steam cylinder and base to prevent short-term blockage from reoccurring Check blow-down pump, drain assembly and cylinder for mineral deposits and clean.
	X	Max.-Level Fault Unit shuts off automatically.	<ul style="list-style-type: none"> If the water level “max. level” is reached, the pump switches on and drains the cylinder until the water level lowers to “operation.” If the “max.-level” is reached five times, “max.-level” is displayed. Air pressure in the duct is too high. Duct air pressure enters the cylinder via the steam hose. Water is forced into the drain. 	<ul style="list-style-type: none"> Reduce air pressure or detach vent pipes from the unit and place higher

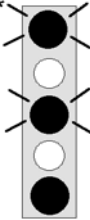
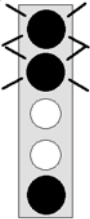
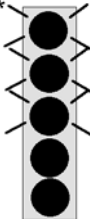
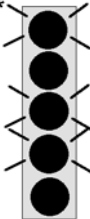
LED Display	HE*** ESH***	Message / Mal-function Displayed*	Probable Cause	Resolution
	X	Max.-Level Fault Unit shuts off automatically.	<ul style="list-style-type: none"> • Solenoid valve does not close properly. Water level in the cylinder rises slowly even though the solenoid valve has not been activated. • Water is supplied even though the steam humidifier is switched off. Solenoid valve remains open. • Inlet solenoid valve is receiving a constant electric signal. (If the unit is turned off, water feeding stops.) • Large amounts of deposits are interfering with and disrupting the blow-down cycle. Due to extra water entering the flushing mechanism, the max.-level is reached during the blow-down process. 	<ul style="list-style-type: none"> • Check solenoid valve. • Clean solenoid valve. • The relay on the main PCB has stuck. Measure voltage at PBC-terminal 10 against N. • Clean humidifier, drain assembly and hose to the control cylinder.
	X	Message Cylinder Full	<ul style="list-style-type: none"> • Nominal current or nominal output not reached although cylinder filled up to maximum-limitations electrode. Water input is interrupted. Possible causes: <ul style="list-style-type: none"> - Water conductivity too low. - Cold start - Re-start following full blow-down. - Changing water conductivity. - Electrodes worn out. • Unit requires maintenance. • No electrode supply cable fed through current transducer ring. 	<ul style="list-style-type: none"> • Continuous steam production and increasing water conductivity can cause the control lamp to switch off automatically after a period of operation time. nominal output is reached automatically. • Check water values and/or contact HygroMatik. • Replace electrodes. • See Service section in unit handbook. • Feed a cable through current transducer ring.
	X X	System failure	<ul style="list-style-type: none"> • Mainboard is defective 	<ul style="list-style-type: none"> • Check mainboard. If necessary - change mainboard

LED Display	HE*** ESH***	Message / Mal-function Displayed*	Probable Cause	Resolution
	<p>X X</p>	<p>Fault Filling Unit shuts off automatically.</p>	<ul style="list-style-type: none"> • Solenoid valve or feed line is fouled or defective. • Defective coil. • Water supply is not open. • Solenoid valve has not been electrically activated. <ul style="list-style-type: none"> - The cable connections are faulty. - The relay on the main PCB is not operating. • The steam hose has not been laid at enough of an incline, causing a water pocket to form. The steam flow is obstructed. 	<ul style="list-style-type: none"> • Clean or replace solenoid valve or feed line. • Measure coil and replace. • Open water supply. • Check or replace cable connections. • Measure voltage at PCB terminal 11 against N or replace PCB • Check placement of steam hose. Remove water pocket.
	<p>X X</p>	<p>Main Contactor Fault Unit shuts off automatically</p>	<ul style="list-style-type: none"> • Main contactor does not drop out. • Relay on the PCB is stuck. 	<ul style="list-style-type: none"> • Replace main contactor. • Replace PCB.
	<p>X X</p>	<p>Fault RH Sensor (Fault Humidity Sensor) Unit shuts off automatically.</p>	<ul style="list-style-type: none"> • Humidity sensor or line defective. 	<ul style="list-style-type: none"> • Check humidity sensor and sensor line, replace if needed.
	<p>X</p>	<p>Fault Level Sensor Unit shuts off automatically.</p>	<ul style="list-style-type: none"> • Cable connections for the float switch are faulty. • Plug for the float switch is not connected to the control • Wrong connection of external control signal 	<ul style="list-style-type: none"> • Check cable connections, replace if needed. • Connect plug to the control. • Check connection of external control signal on terminals 4 and 5

LED Display	HE*** ESH***	Message / Mal-function Displayed*	Probable Cause	Resolution
	X	Fault Activated Thermo Sensor Unit shuts off automatically.	<ul style="list-style-type: none"> Thermo sensor on the top of the cylinder has been activated (HeaterLine = 2 thermo sensors, HeaterCompact = 1 thermo sensor). Heating element is coated by lime. Thermosensor on the heat sink for the solid state relay has been activated. Openings for chimney are covered. 	<ul style="list-style-type: none"> Disconnect power supply. Wait until cylinder has cooled down. Press the release pin back down with needle-nose pliers or a screwdriver. Remove lime. Press the release pin back down and remove the blocking elements.
	X	Fault Steam-Down Time Exceeded Unit shuts off automatically.	<ul style="list-style-type: none"> Heater element is defective. Phase failure. (External breaker has been tripped or is defective.) Heater element is not being supplied with current. Main contactor is not switching correctly. PCB does not activate main contactor. 	<ul style="list-style-type: none"> Measure resistance of the heater element, replace heater element if needed. Heater element resistance at 4.5 kW: ca. 36 Ohm and at 6.75 kW: 24 Ohm Replace circuit breaker and identify cause. Check cable connections. Measure voltage. Check main contactor, replace if needed. Measure voltage at PCB terminal 10 against N. Replace PCB if necessary.
	X X	Maintenance Intervall	<ul style="list-style-type: none"> The maintenance interval has expired. 	<ul style="list-style-type: none"> Service or check steam humidifier. Reset the maintenance interval at Parameter P3 "Reset Maintenance Interval". With Parameter P2, the maintenance interval can be adjusted to the feed water quality.
	X X	No steam production, display reads: no demand	<ul style="list-style-type: none"> The humidifier shuts off in response to a (control) signal of less than 20% and switches back on at 25%. The demand is too low. Incorrect control signal adjustment. 	<ul style="list-style-type: none"> Increase desired value. Check settings of parameters "E3" and "U6".
	X X	Lost Ground Control	<ul style="list-style-type: none"> Communication between main board and display is disturbed Display and / or main board defective 	<ul style="list-style-type: none"> Check cable and RS485 interface modules (only valid for ComfortPlus control and remote control) Change display and / or main board

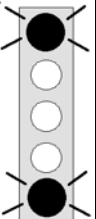
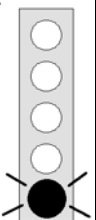
LED Display	HE*** ESH***	Message / Malfunction Displayed*	Probable Cause	Resolution
<p>*</p> 	<p>X X</p>	<p>No steam production. Display reads: Stand-by</p>	<ul style="list-style-type: none"> • Safety interlock is open.  <ul style="list-style-type: none"> • If no safety interlock is present, for example a max.-hygrostat, absence of a jumper between terminals 1 and 2 prevents unit start-up. • If the humidity exceeds the hygrostat's set value, there will be no demand. • If the control signal adjustment is incorrect, the unit cannot operate. 	<ul style="list-style-type: none"> • Identify malfunction and repair. If necessary, install a jumper between terminals 1 and 2. <p>Warning: Remove installed jumper after malfunction is repaired.</p> <ul style="list-style-type: none"> • Install jumper between terminals 1 and 2. • Check settings, increase desired humidity value if needed. Check hygrostat function. <p>Note: Performing a signal test and a demand test may yield additional information about the problem.</p> <ul style="list-style-type: none"> • Check settings of parameters "E3" and "U6".
<p>*</p> 	<p>X</p>	<p>Service</p> <p>The system switches off after 60 min. in operation in cylinder full condition.</p>	<ul style="list-style-type: none"> • Unit requires maintenance: <ul style="list-style-type: none"> - Cylinder full of scale deposits which limit the electrodes immersion depth. - Electrodes worn out. • Phase defective (external fuse faulty). • Phase L3 is not fed through current transducer ring. • With very low water conductivity continuous steam production is insufficient in order to concentrate and raise the water conductivity. 	<ul style="list-style-type: none"> • Clean steam cylinder and electrodes or replace electrodes. Replace electrodes. (If electrode wear is high, see note in section „Electrode Exchange“ in unit handbook) • Replace fuse. • Feed phase through current transducer ring. • Establish water values and/or contact HygroMatik about the problem.
<p>*</p> 	<p>X X</p>	<p>Maintenance K1</p> <p>The system still operates.</p>	<ul style="list-style-type: none"> • After the preprogrammed number of operations of the main contactor (K1) the control provides the message "Maintenance K1". It is recommended to swap the main contactor. 	<ul style="list-style-type: none"> • Swap main contactor. • See parameter description "P11 reset main contactor interval" for Comfort / Comfort Plus control or "Brief Description of Jumpers" for Basic control.

LED Display	HE*** ESH***	Possible Condition	Probable Cause	Resolution
	XX	set humidity level has not been reached	<ul style="list-style-type: none"> • The unit's steam generation output limitation is impeding full output • Nominal unit output is not sufficient. • Phase or heater element failure. • Thermo sensor has been activated. (only for Humidifer type HeaterLine) • Long steam hose length in cold and drafty rooms can lead to increased formation of condensate. • Incorrect installation of the steam manifold can produce condensate build-up in the air duct. • Incorrect control signal adjustment leads to faulty and possibly excessive output. • Water quality requires water concentration for full output 	<ul style="list-style-type: none"> • Check steam generation output limitation parameter "P1". • Check output data, air flow, also check secondary air flow • Check breakers and heater elements. • Disconnect power supply. Push down on the release pin with bent needle-nose pliers. • Install the unit in another location to reduce the required hose length. • Check placement in the system and installation. • Check control signal and parameter "E3".
	XX	Too much humidity	<ul style="list-style-type: none"> • Too high a steam generation output limitation can cause poor control and even produce formation of condensate in ducts. • Incorrect control signal adjustment produces excessive output. 	<ul style="list-style-type: none"> • Check steam generation output limitation. • Check control signal and parameter "E3".
	XX	Water is collecting on the base plate	<ul style="list-style-type: none"> • Cylinder improperly assembled after maintenance: <ul style="list-style-type: none"> - O-Ring has been damaged, has not been replaced, or has not been inserted - Flange (slot / spring) is damaged - Flange has not been sealed properly - Mineral deposits in the flange. • The cylinder is incorrectly placed on the base. • The water cannot drain away during flushing. 	<ul style="list-style-type: none"> • Clean cylinder and install properly. • Lay a moistened new o-ring in the base and then insert the cylinder. • Make sure drain is unobstructed.

LED Display	HE***	ESH***	Possible Condition	Probable Cause	Resolution
	X	X	Water is leaking from upper part of steam cylinder.	<ul style="list-style-type: none"> • Hose clamps on the steam or condensate hose do not close tightly. • The heater element or thermo sensor has not been properly installed. • Steam hose adapter has not been correctly installed or o-ring has not been changed. • If condensate is not into the steam cylinder, the condensate connection must have a condensate plug. 	<ul style="list-style-type: none"> • Tighten hose clamps. • Install heater element and thermo sensor as specified in the unit manual. • Replace o-ring and correctly install steam hose adapter. • Install condensate plug.
	X	X	No steam production even though the steam generator is on. The display is dark	<ul style="list-style-type: none"> • Defective fuse F1 1.6 A. • Phase failure L3. (External breaker has been tripped or is defective.) 	<ul style="list-style-type: none"> • Check micro fuse and replace, also see Section „Wiring diagram“. • Replace external breaker and investigate possible causes.
	X	X	Blow-down pump is working, but no water is being flushed	<ul style="list-style-type: none"> • Cylinder base or blow-down system is blocked. 	<ul style="list-style-type: none"> • Clean cylinder base or blow-down system.
	X	X	Cylinder has completely drained after a blow-down, even though pump is switched off.	<ul style="list-style-type: none"> • Vent pipe is blocked. 	<ul style="list-style-type: none"> • Clean or replace vent tube. Replace vent pipe adapter. Also see unit manual.

LED Display	HE***	ESH***	Possible Condition	Probable Cause	Resolution
	X	X	<p>No steam is exiting the steam manifold.</p> <p>Water leaks periodically from the drain hose while the pump is not running.</p>	<ul style="list-style-type: none"> • Incorrect placement of steam line (water pocket) • Excess pressure in duct system (max. overpressure 1200 Pa) 	<ul style="list-style-type: none"> • Lay steam hose as specified in Section “types of installation“ in the unit manual. • Lengthen drain hose, consult with HygroMatik if necessary.
	X		<p>Uneven electrode wear</p>	<ul style="list-style-type: none"> • Electrode(s) is/are not supplied with power. • Breaker has been tripped. • Main contactor does not operate. • Uneven working load • Uneven immersion depth of electrodes. The unit has not been mounted plumb and level. 	<ul style="list-style-type: none"> • Check breaker, replace if necessary • Check main contactor, replace if needed. • Check power supply (measure voltage differential.) • Install unit plumb and lev
	X		<p>Light / sparks in the cylinder</p>	<ul style="list-style-type: none"> • The appearance of light or sparks suggests rapid loss of electrode material (brown-black deposits) and very high water conductivity. <p>In these cases, consult HygroMatik.</p> <ul style="list-style-type: none"> • Blow-down pump is not working properly or is defective. 	<ul style="list-style-type: none"> • Deactivate the unit immediately to prevent it from being damaged. <p>Perform maintenance:</p> <ul style="list-style-type: none"> - Replace electrodes - Clean steam cylinder - Check water quality or conductivity, also see Section „Directions for Use“ . <p>Increase blow-down frequency and/or blow-down volume.</p> <ul style="list-style-type: none"> • Check blow-down pump function and replace blow-down pump if necessary. See message Blow-Down Fault

* :

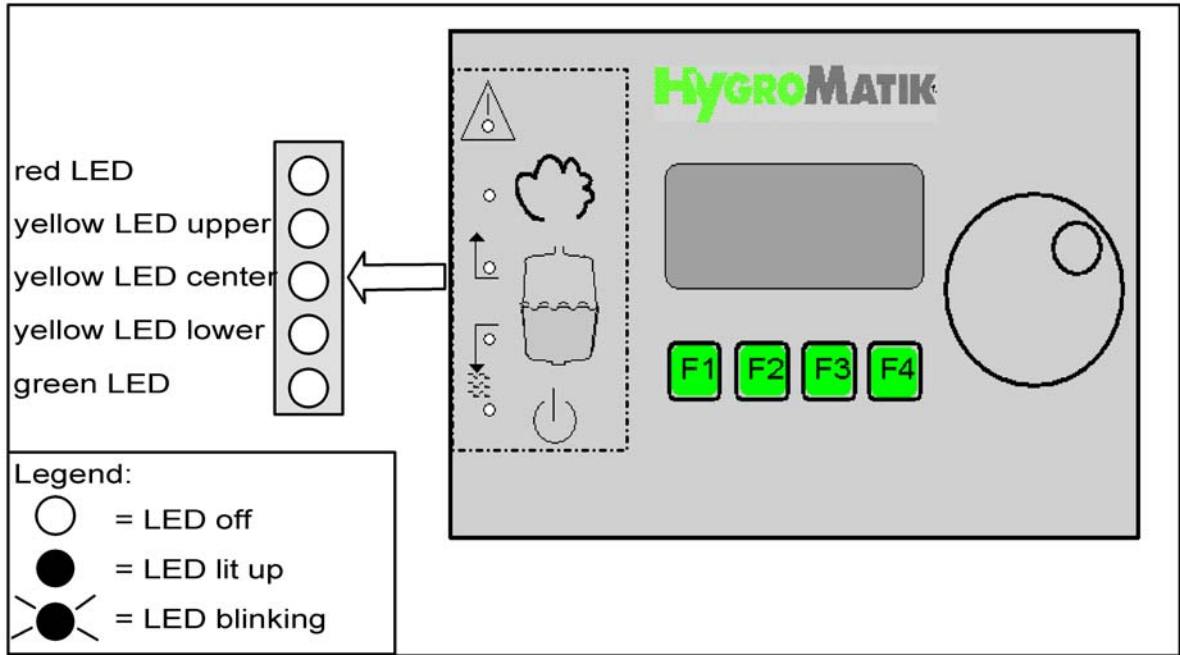

** Only Comfort / Comfort Plus

*** ESH = electrode steam humidifier; HE = heater element humidifier

10. Basic PCB Connections

Main PCB		Steam Humidifier	
B3	current transducer(only for Humidifier type HyLine, CompactLine, MiniSteam)	B1	sensor electrode
D6	fault indicator lamp (red)	F1	controller fuse 1.6 A
D64	humidifying indicator lamp (yellow)	K1	main contactor
D 63	filling indicator lamp (yellow)	L1-L3	main terminal
D62	blow-down indicator lamp (yellow)	M1	blow-down pump
D61	operating indicator lamp (green)	M2	motor fan (MiniSteam only)
P1	potentiometer steam generation output limitation 25 - 100% steam generation ouput limitation	S1	control switch Off Pos. 0 On Pos. I Draining Pos. II
P2	potentiometer pump run time 0 - 45 sec.	Y1	solenoid valve
4 - 5	external control signal	Y2	solenoid valve for flushing mechanism
3	24 V DC	1-2	terminals for hygrostat and safety interlock
6 - 7	sensor electrode input(ST2)	4-5	terminals for external control signal
9	main contactor output(ST1)	3	24V
10	pump output(ST1)		
11	solenoid valve output(ST1)		
12 - 13	0-10 V output (control signal)		
15 - 16	control power supply (ST1)		
16	blow-down pump power supply (ST1)		
19, 17, 18	semiconductor relay exit (ST5) (only Humidifier type HeaterLine)		
21 - 24	level control swith (ST6) (only Humidifier type HeaterLine)		
28 - 30	signal relay (collective fault)(ST4)		
31 - 42	optional: 4 signal relay ouputs (see JP3)		
JP1	jumper terminal basic settings		
ST 8	connector COM-Port		
ST 9	connector remote control		
JP 9 / JP 4	jumper socket interface driver		
JP 5	socket display		
JP 3	jumper socket signal relay		

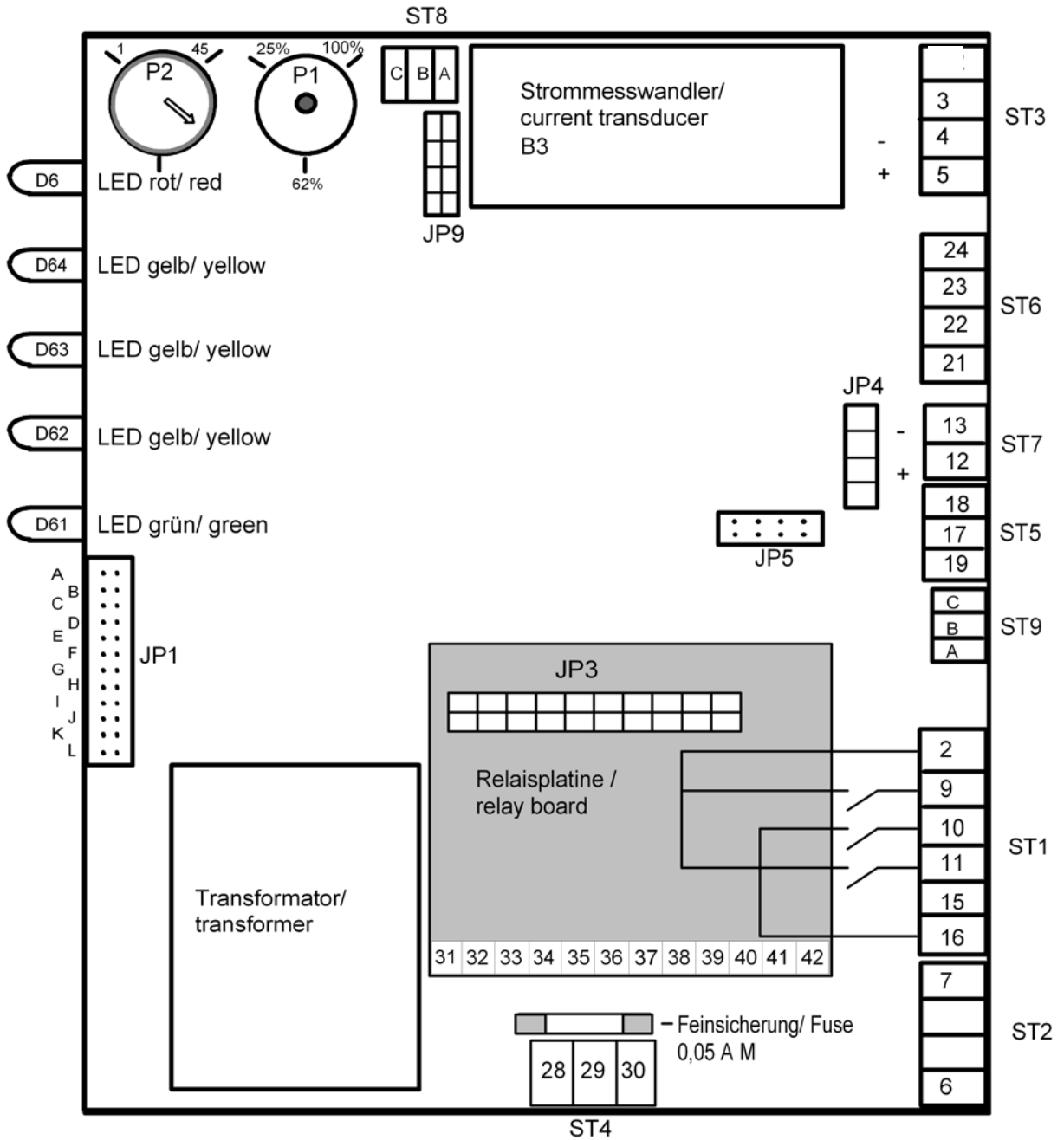

11. Wiring Diagram

Steam Humidifier

28 - 30	signal relay (collective fault)(ST4)	B1	sensor electrode
31 - 42	optional: 4 signal relay outputs (see JP3)	F1	controller fuse 1.6 A
JP1	jumper terminal basic settings	K1	main contactor
ST 8	connector COM-Port	L1-L3	main terminal
ST 9	connector remote control	M1	blow-down pump
JP 9 / JP 4	jumper socket interface driver	M2	motor fan (MiniSteam only)
JP 5	socket display	S1	control switch
			Off Pos. 0 On Pos. I/
			Abschlämmen Po. II
JP 3	jumper socket signal relay	Y1	solenoid valve
		Y2	solenoid valve for flushing mechanism
		1-2	terminals for hygrostat and safety interlock
		4-5	terminals for external control signal
		3	24V

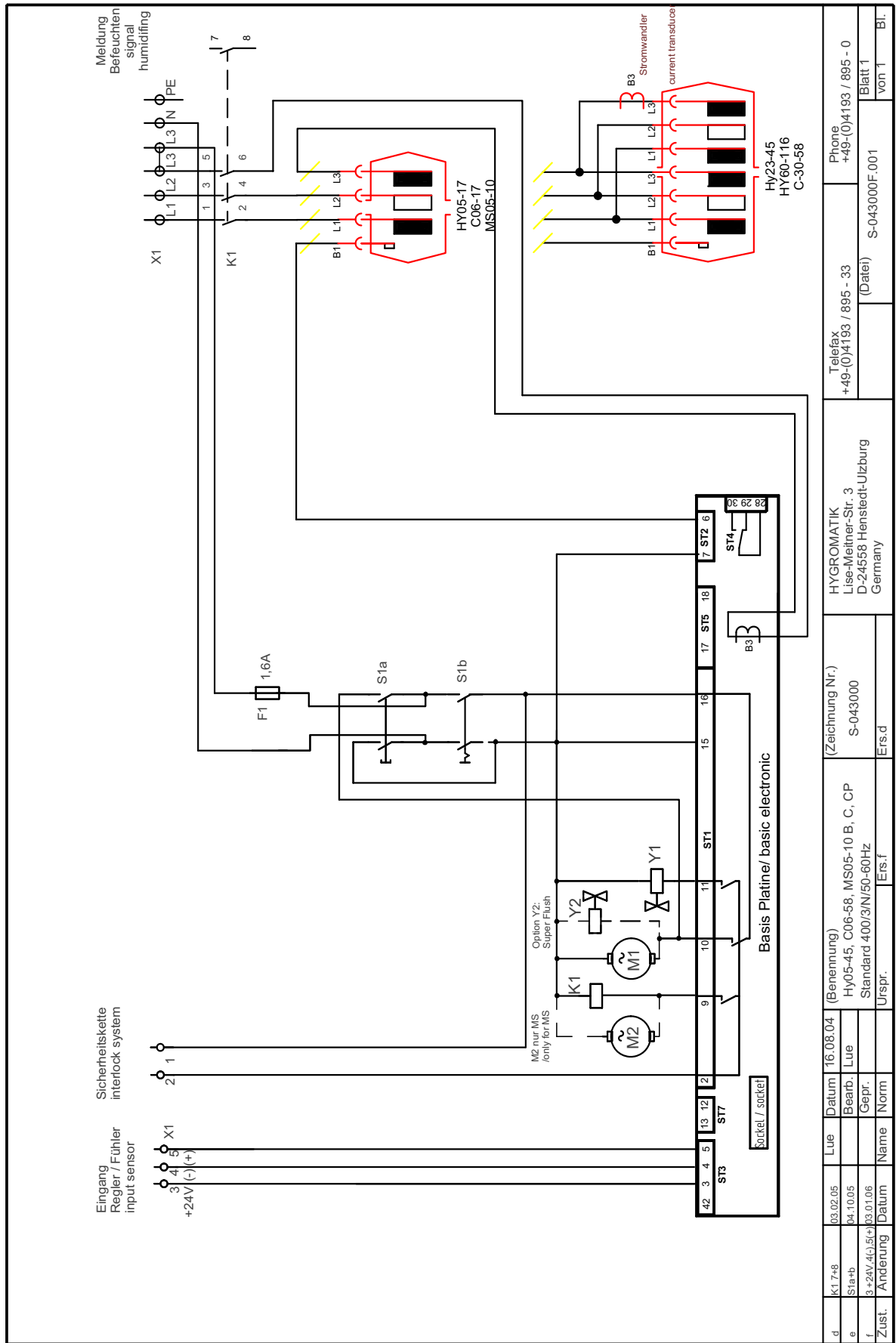

d	K1.7+8	03.02.05	Lue	Datum	16.08.04	(Benennung)	HYGROMATIK	Telefax	Phone
e	S1a+b	04.10.05	Lue	Bearb.	S-043000	Hy05-45, C06-58, MS05-10 B, C, CP	Lise-Melther-Str. 3	+49-(0)4193 / 895 - 33	+49-(0)4193 / 895 - 0
f	3+24V,4(+),5(+)	03.01.06	Gepr.	Gepr.	Ers.f	Standard 400/3/N/50-60Hz	D-24558 Hensfeld-Utzburg	(Datei)	S-043000F.001
Zust.	Änderung	Datum	Name	Norm	Urspr.	Ers.d	Germany	Blatt 1	Von 1
									Bl.

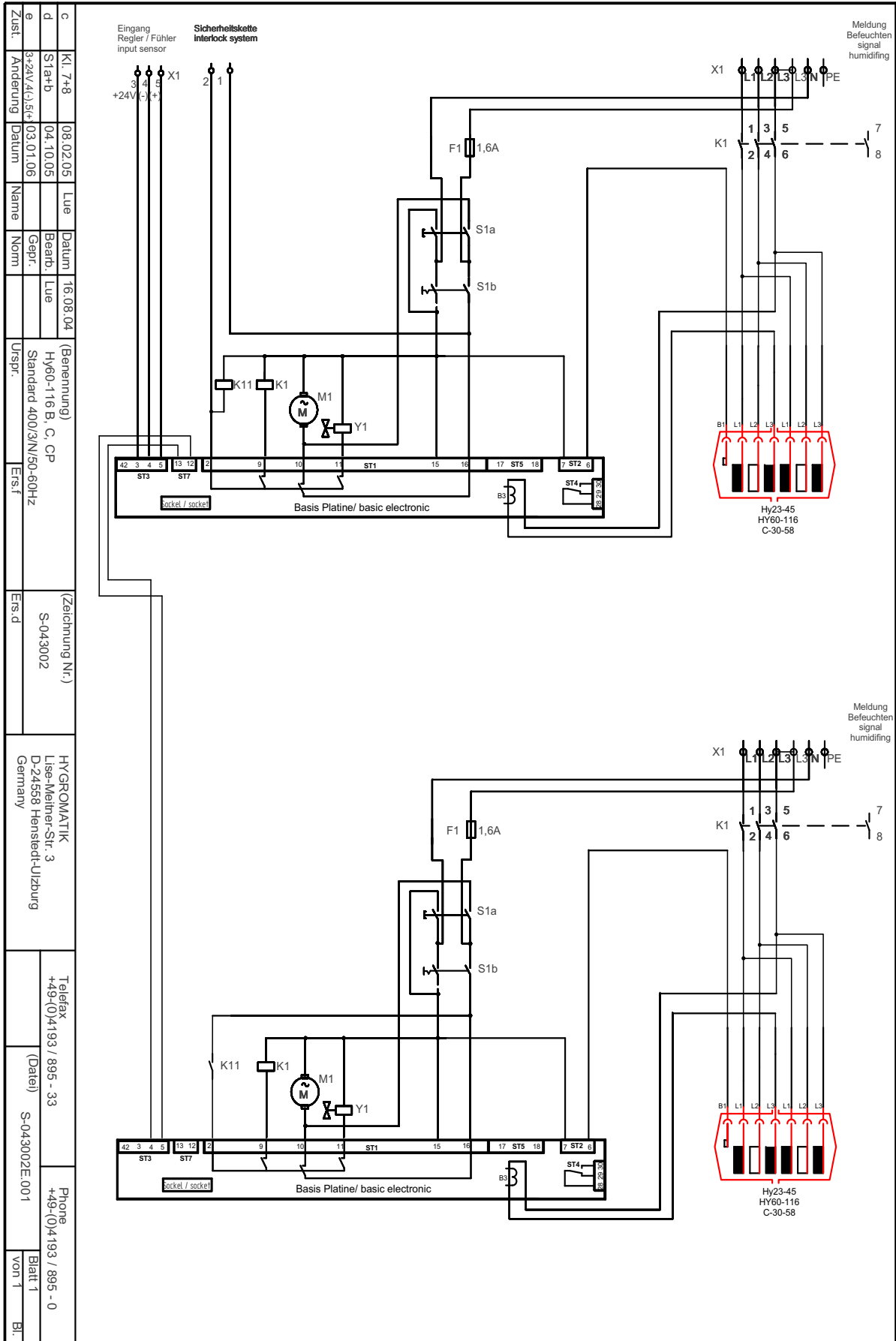

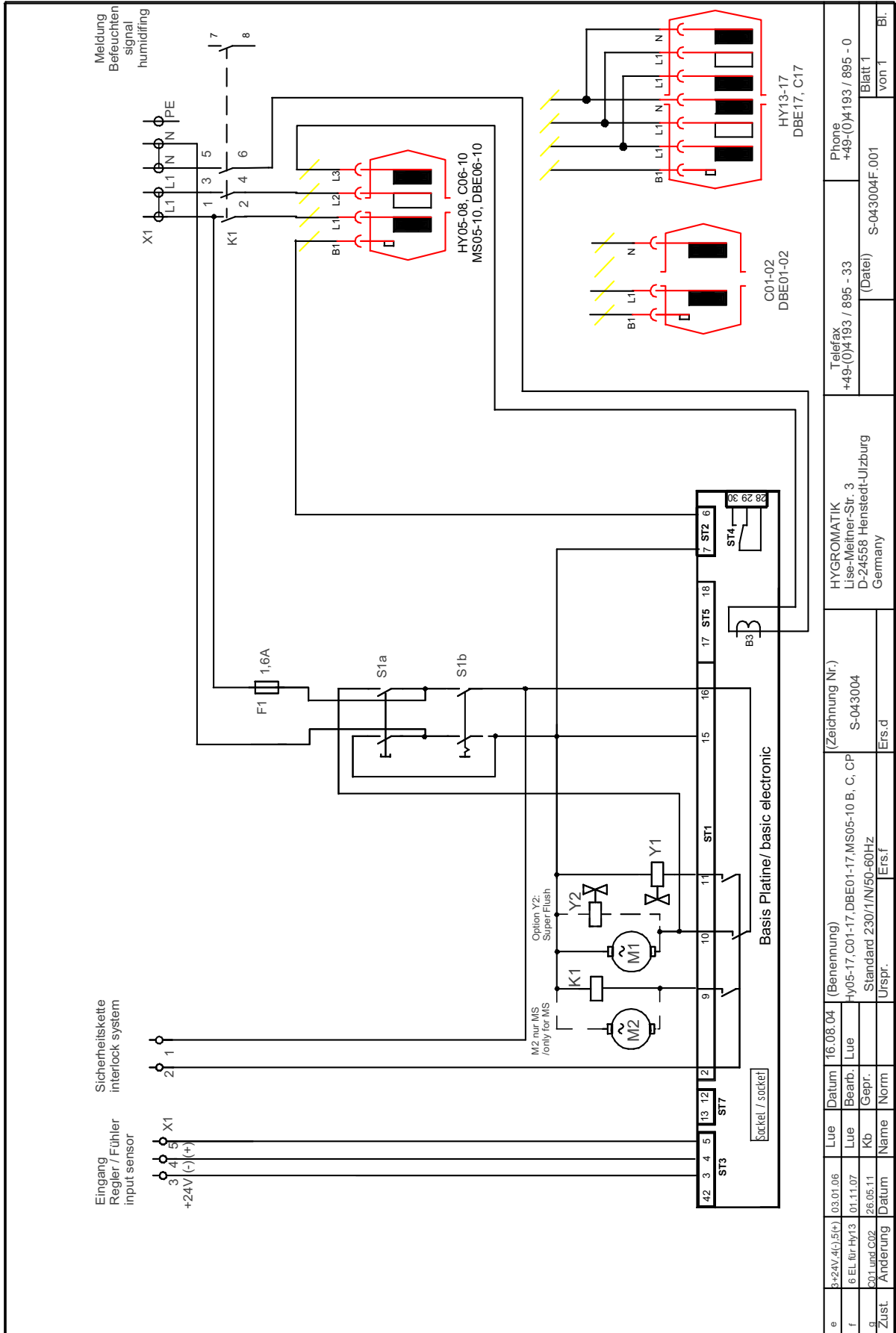

e	3+24V, 4(+), 5(+)	03.01.06	Lue	Datum	16.08.04	(Benennung)	HYGROMATIK	Telefax	Phone
f	6 EL für Hyr.3	01.11.07	Lue	Bearb.	Lue	hy05-17, C01-17, DBE01-17, MS05-10 B, C, CP	Lise-Melner-Str. 3	+49-(0)4193 / 895 - 33	+49-(0)4193 / 895 - 0
g	201 und C02	26.05.11	Kb	Gepr.	Standard 230/1/N/50-60Hz	D-24558 Henstedt-Utzburg	Germany	(Date)	S-043004F.001
Zust.	Anderung	Datum	Name	Norm	Urspr.	Ers.f	Ers.d		Blatt 1
									von 1

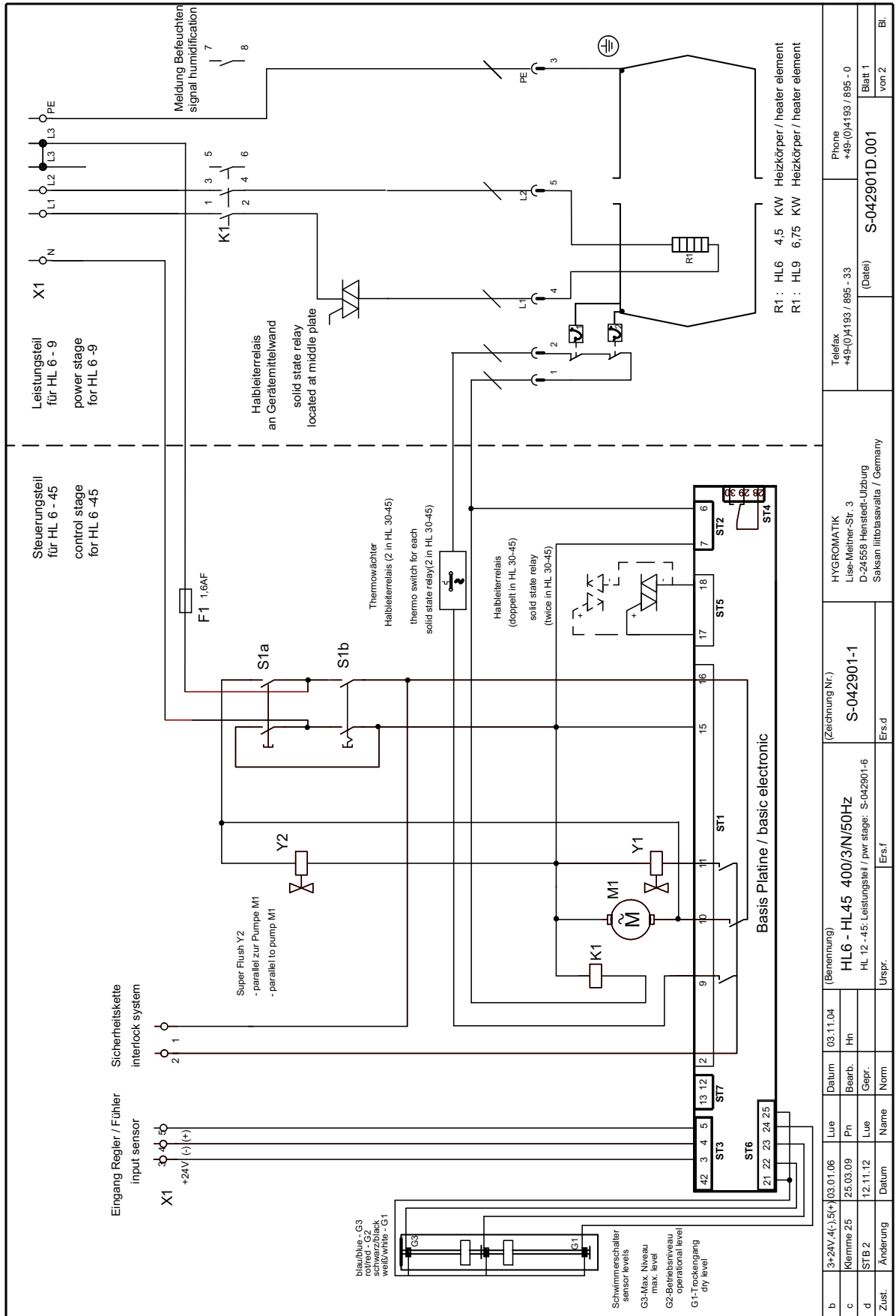

b	3+24V, 4(-), 5(+)	03.01.06	Lue	Datum	03.11.04	(Benennung)	HL6 - HL45 400/3N/50Hz	(Zeichnung Nr.)	S-042901-1	HYGROMATIK Lisa-Meine-Str. 3 D-24556 Henstedt-Ulzburg Saksan Iittolaosavalla / Germany	Telefax +49-(0)4193 / 895 - 33	Phone +49-(0)4193 / 895 - 0
c	Klemme 25	25.03.09	Ph	Bearb.	Hn		HL 12 - 45: Leistungssteil / pwr stage: S-042901-6				(Date)	S-042901D.001
d	STB 2	12.11.12	Lue	Gepr.								Blatt 1 von 2
Zust.	Änderung	Datum	Name	Norm	Urspr.	Ers.f						Bl.

a	HL27	14.07.05	Lue	Datum	03.11.04	(Benennung)	Leistungsteil HL 12-45 400V/3N 50-60HZ	Ers.f	Ers.d	S-042901-6	Zuführung Nr.)
b	R1 - R5	08.05.08	Dg	Bearb.	Lue						
c	STB 2	12.11.12	Lue	Gepr.							
Zust.	Anderung	Datum	Name	Norm		Urspr.					
HYGROMATIK Lieke-Meiner-Str. 3 D-24558 Henstedt-Ulzburg Germany Telefax +49-(0)4193 / 895 - 33 (Datei) S-042901C.002 Phone +49-(0)4193 / 895 - 0 Blatt 2 von 2											

HL 12 / HL 18

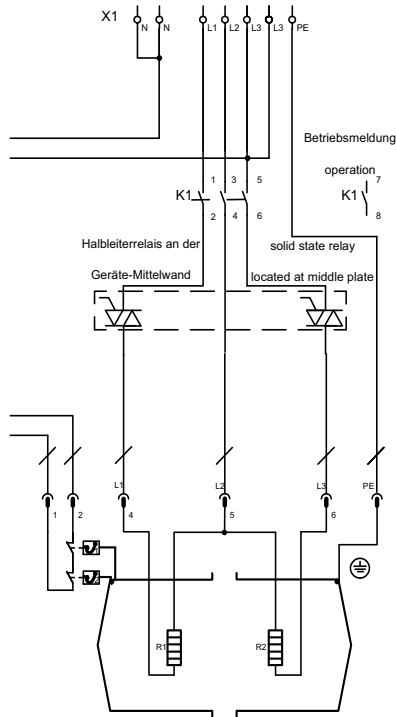

R1 - R2 in HL12 4,5 KW Heizkörper / heating element
 R1 - R2 in HL18 6,75 KW Heizkörper / heating element

HL 27 / HL18

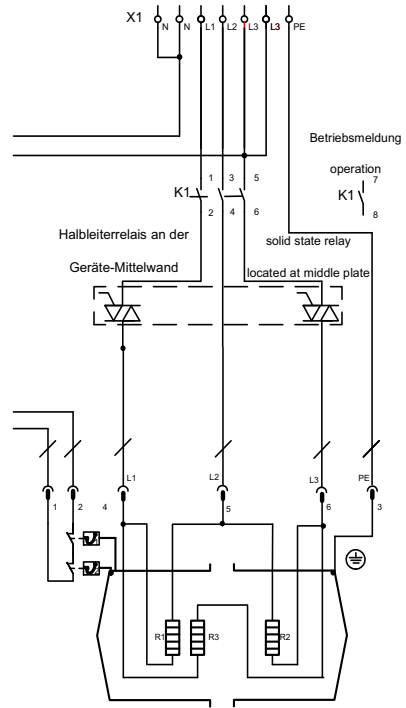

R1 - R3 in HL27 6,75 KW Heizkörper / heating element
 R1 - R3 in HL18 4,5 KW Heizkörper / heating element

HL 30 / HL 45

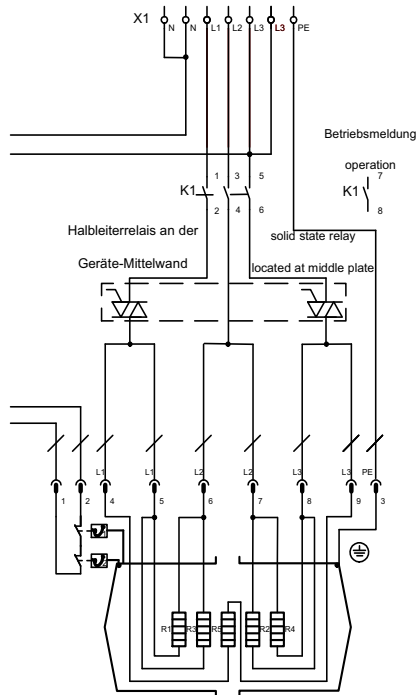

R1 - R5 in HL30 4,5 KW Heizkörper / heating element

HL 24 / HL 36

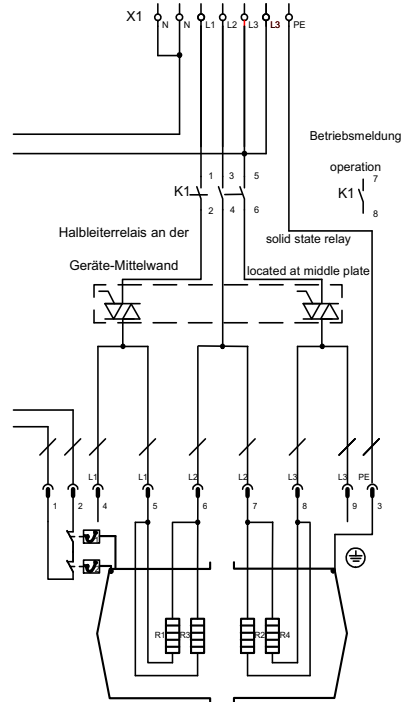

R1 - R4 in HL24 4,5 KW Heizkörper / heating element

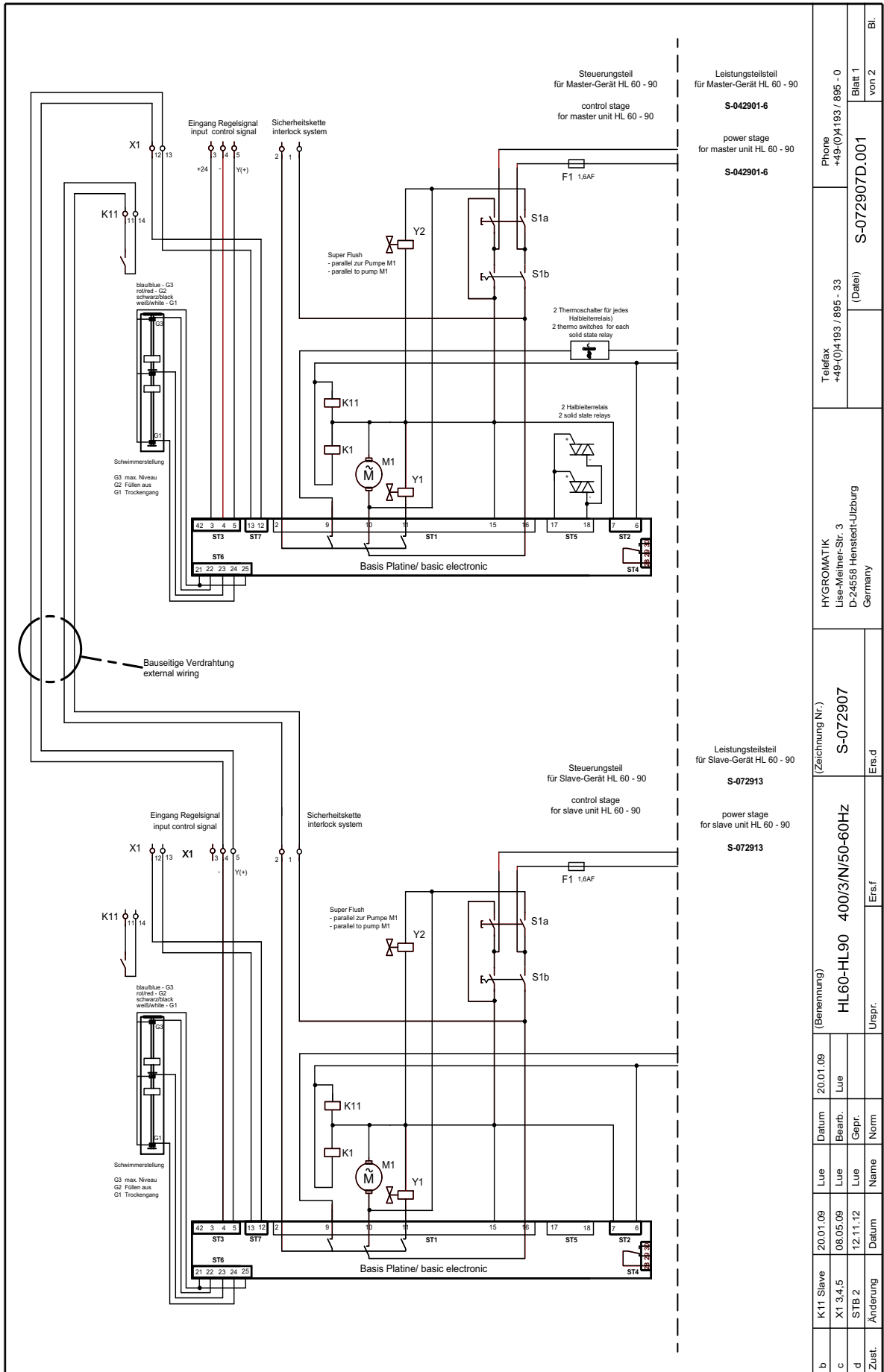

Leistungsteilsteil für Master-Gerät HL 60 - 90
control stage for master unit HL 60 - 90
S-042901-6
power stage for master unit HL 60 - 90
S-042901-6

Leistungsteilsteil für Slave-Gerät HL 60 - 90
control stage for slave unit HL 60 - 90
S-072913
power stage for slave unit HL 60 - 90
S-072913

b	K11 Slave	20.01.09	20.01.09	HL60-HL90 400/3/N/50-60HZ		Ers.f	Ers.d	S-072907	HYGROMATIK Lise-Meißner-Str. 3 D-24568 Henstedt-Ulzburg Germany	S-072907D.001	Phone +49-(0)4193 / 895 - 0	Blatt 1 von 2
		Datum	Datum	(Benennung)	(Date)							
c	X1 3.4.5	08.05.09	Lue	Lue								
d	S1B 2	12.11.12	Lue	Lue								
Zust.	Änderung	Datum	Name	Gepr.								

HL 30 / 45 Slave

- (HL 60: HL30 + HL30 Slave)
- (HL 90: HL45 + HL45 Slave)
- (HL 135: HL45 + 2*HL45 Slave)
- (HL 180: HL45 + 3*HL45 Slave)
- (HL 225: HL45 + 4*HL45 Slave)

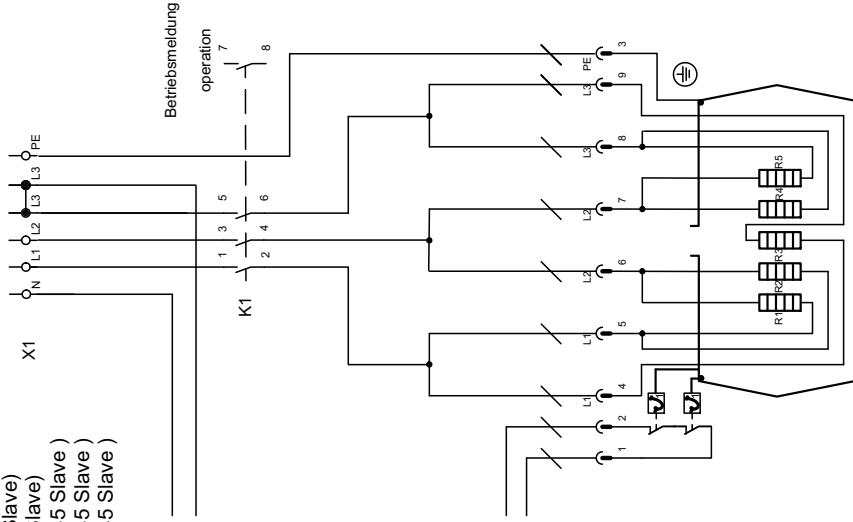

R1 - R5 in HL30 (slave) : 4,5 KW Heizkörper / heating element
 R1 - R5 in HL45 (slave) : 6,75 KW Heizkörper / heating element

HL 36 Slave

- (HL 70: HL36 + HL36 Slave)
- (HL 80: HL45 + HL36 Slave)

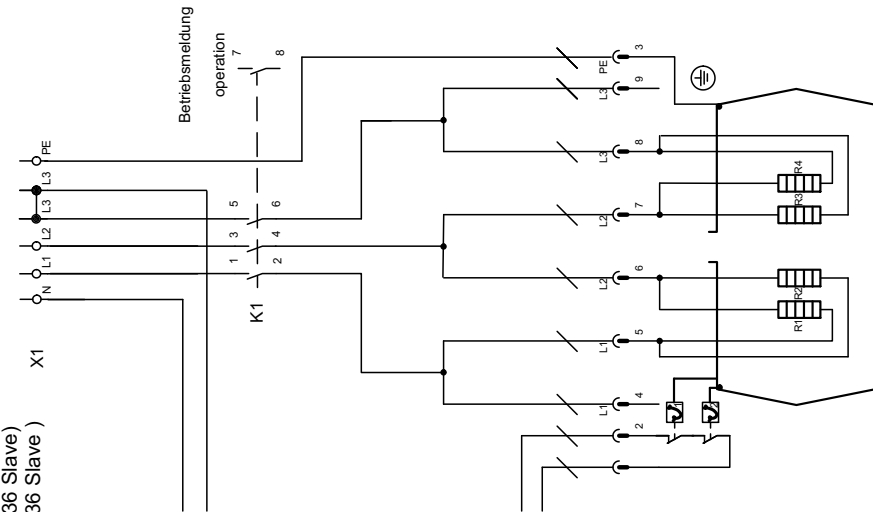

R1 - R4 in HL36 (slave) : 6,75 KW Heizkörper / heating element

a	erstellt	12.11.12	Lue	Datum	12.04.07	(Benennung)	Leistungsteil HL Slave 60-90	(Zeichnung Nr.)	S-072913	HYGROMATIK Lise-Meißer-Str. 3 D-24568 Henstedt-Ulzburg Germany	Telefax +49-(0)4193 / 895 - 33	Phone +49-(0)4193 / 895 - 0
b				Bearb.	Hh							
c				Gepr.		400V/3N/50-60Hz						
Zusf.	Änderung	Datum	Name	Norm	Urspr.	Ers.f					(Datei)	S-072913A.001
												Blatt 2 von 2

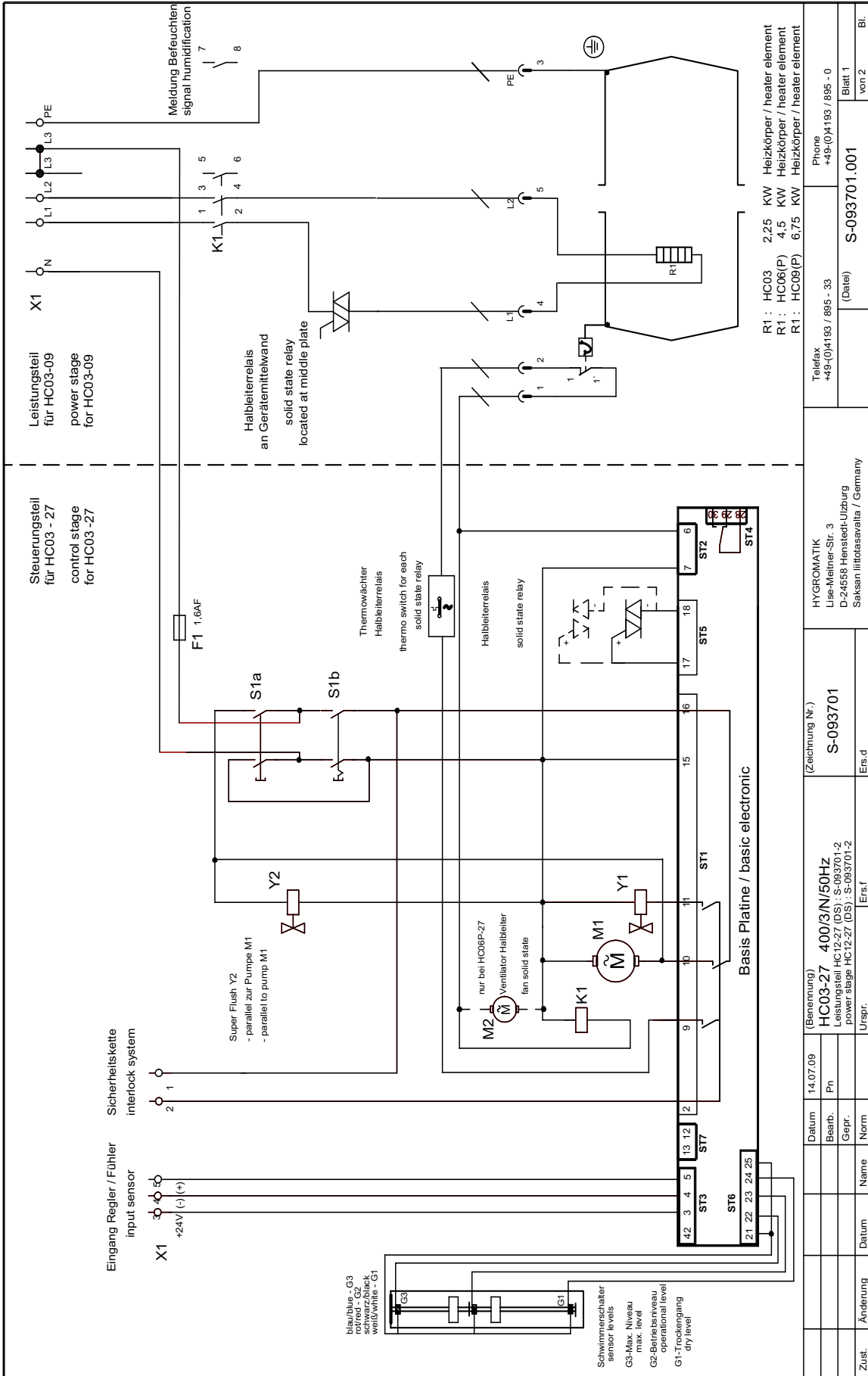

HYGROMATIK Lise-Meltner-Str. 3 D-24558 Henstedt-Ulzburg Saksan liitotasavalta / Germany		Telephone +49-(0)4193 / 895 - 33	Phone +49-(0)4193 / 895 - 0
(Zeichnung Nr.) S-093701		(Datei) S-093701.001	Blatt 1 von 2
(Benennung) HC03-27 400/3/N/50HZ Leistungsrel. HC12-27 (DS) ; S-093701-2 power stage HC12-27 (DS) ; S-093701-2	Datum 14.07.09	Urspr.	
Bearb. Pn		Ers.f	
Gepr.			
Änderung	Datum	Name	
Zust.			Bl.

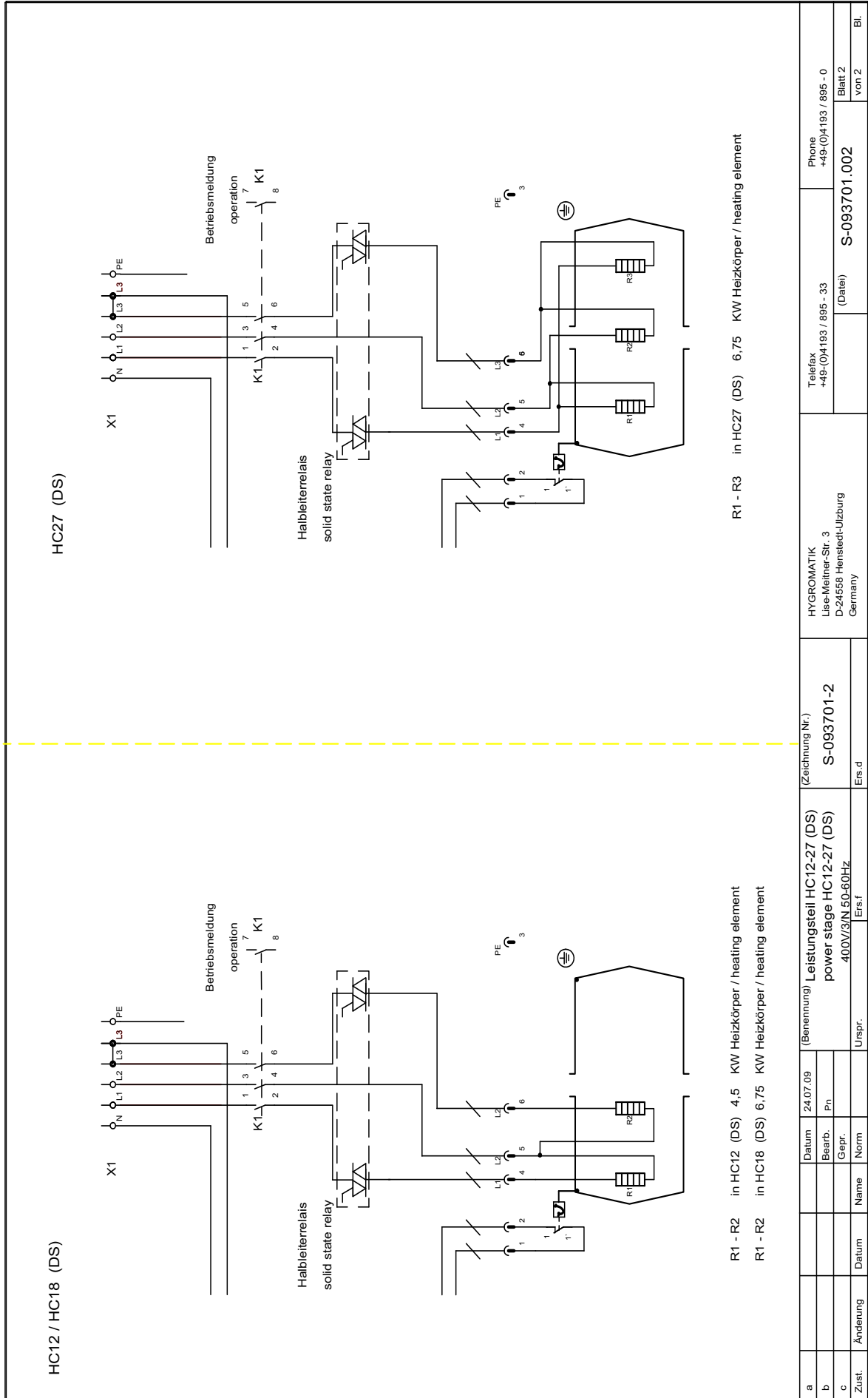

HC27 (DS)

HC12 / HC18 (DS)

R1 - R3 in HC27 (DS) 6,75 KW Heizkörper / heating element

R1 - R2 in HC12 (DS) 4,5 KW Heizkörper / heating element

R1 - R2 in HC18 (DS) 6,75 KW Heizkörper / heating element

a	Datum	24.07.09	(Benennung) Leistungsteil HC12-27 (DS)	(Zeichnung Nr.)	HYGROMATIK Lise-Meiner-Str. 3 D-24558 Henstedt-Utzburg Germany	Telefax +49-(0)4193 / 895 - 33	Phone +49-(0)4193 / 895 - 0
b	Bearb.	Pn	power stage HC12-27 (DS)	S-093701-2			
c	Gepr.		400V/3/N 50-60Hz	Eis.d		(Date)	Blatt 2 von 2
Zust.	Änderung	Datum	Name	Urspr.			S-093701.002
				Eis.f			Bl. von 2

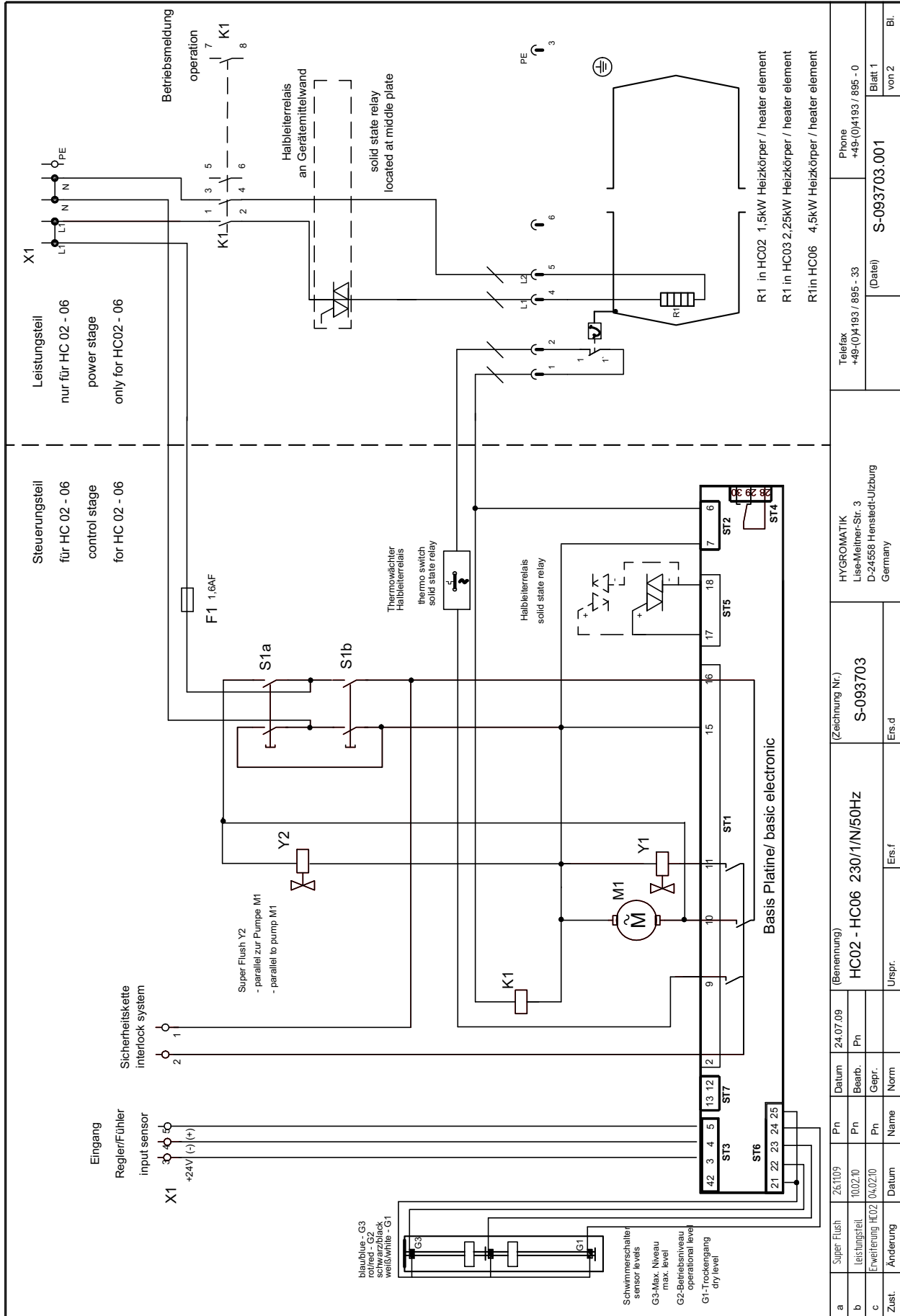

a	Super Flush	Z61109	Ph	Datum	24.07.09	(Benennung)	HC02 - HC06 230/1N/50Hz	(Zeichnung Nr.)	S-093703	HYGROMATIK Lisa-Meiner-Str. 3 D-24568 Henstedt-Ulzburg Germany	Telefax +49-(0)4193 / 895 - 33	Phone +49-(0)4193 / 895 - 0
b	Leistungsteil	1002/0	Ph	Bearb.	Ph						(Date)	S-093703.001
c	Erweiterung HC02	04.02.10	Ph	Gepr.	Norm							Blatt 1 von 2
Zust.	Änderung	Datum	Name	Urspr.	Ers.f	Ers.d						Bl.

12. Technical Specifications

Heater Element Steam Humidifier									
Type HeaterLine	HL06	HL09	HL12	HL18	HL24	HL30	HL36	HL45	
Steam Output [kg/h]	6	9	12	18	24	30	36	45	
Power Rating [kW]	4,5	6,8	9,0	13,5	18,0	22,5	27,0	33,8	
Power Consumption [A]	11,3	16,8	19,5	29,3	39,0	39	58,5	58,5	
Circuit Protection [A]	3x16	3x20	3x25	3x35	3x50	3x50	3x63	3x63	
Type HeaterLine	HL60	HL70	HL80	HL90					
Steam Output [kg/h]	60	72	81	90					
Number of units	2	2	2	2					
Power Rating [kW] per unit	22,5	27	33,8	33,8					
Power Consumption [A] per unit	39	58,5	58,5	58,5					
Circuit Protection [A] per unit	3x63	3x63	3x63	3x63					
Electrical Connection* per unit	400V/3/N 50-60Hz								
Control Voltage	230V/50-60Hz								

Heater Element Steam Humidifier										
Type Heater-Compact (Kit)	HC02 (Kit)	HC03 (Kit)	HC06 (Kit)	HC06 (Kit)	HC09 (Kit)	HC06P	HC09P	HC12 (Kit)	HC18 (Kit)	HC27 (Kit)
Steam Output [kg/h]	2	3	6	6	9	6	9	12	18	27
Power Rating [kW]	1,5	2,25	4,5	4,5	6,8	4,5	6,8	9,0	13,5	20,3
Power Consumption [A]	6,5	9,8	19,6	11,3	16,9	11,3	16,9	19,5	29,3	29,3
Circuit Protection [A]	1x10	1x10	1x20	3x16	3x20	3x16	3x20	3x25	3x35	3x35
Electrical Supply*	230V/1/N/50-60Hz			400V/3/N 50-60Hz						
Control Voltage	230V/50-60Hz									

*Other voltages upon request.

Electrode Steam Humidifer						
Type HyLine	HY05	HY08	HY13	HY17	HY23	HY30
Steam Output [kg/h]	5	8	13	17	23	30
Power Rating [kW]	3,8	6,0	9,8	12,8	17,3	22,5
Power Consumption [A]	5,4	8,7	14,1	18,4	24,9	32,5
Circuit Protection [A]	3x6	3x10	3x16	3x20	3x35	3x35
Type HyLine	HY45	HY60	HY90	HY116		
Steam Output [kg/h]	45	60	90	116		
Power Rating [kW]	33,8	2x22,5	2x33,8	2x43,5		
Power Consumption [A]	48,8	2x32,5	2x48,8	2x62,8		
Circuit Protection [A] **	3x63	6x35	6x63	6x63		
Electrical Connection*	400V/3/N /50-60Hz					
Control Voltage	230V/50-60Hz					

Electrode Steam Humidifer									
Type CompactLine (Kit)	C01 (Kit)	C02 (Kit)	C06 (Kit)	C10 (Kit)	C17 (Kit)	C22 (Kit)	C30 (Kit)	C45 (Kit)	C58
Steam Output [kg/h]	1	2	6,0	10,0	17,0	22,0	30,0	45,0	58,0
Power Rating [kW]	0,75	1,5	4,5	7,5	12,8	16,5	22,5	33,8	43,5
Power Consumption [A]	3,3	6,5	6,5	10,8	18,4	23,8	32,5	48,8	62,8
Circuit Protection [A] **	1 x 6	1 x 10	3x10	3x16	3x20	3x35	3x35	3x63	3x63
Electrical Connection*	230V/1/N/50-60Hz		400V/3/N/50-60Hz						
Control Voltage	230V/50-60Hz								

Electrode Steam Humidifer			
Type MiniSteam	MS05	MS05	MS10
Steam Output [kg/h]	4,8	5	10
Power Rating [kW]	3,6	3,8	7,5
Power Consumption [A]	15,7	5,4	10,8
Circuit Protection [A] **	1 x 16	3 x 6	3 x 16
Electrical Connection*	230V/1/N50-60Hz		400V/3/N/50-60Hz
Control Voltage	230V/50-60Hz		

*Other voltages upon request.

** 1.3-times power consumption after full blow-down. Note overload capacity of automatic breakers. If necessary, select the next higher rating.

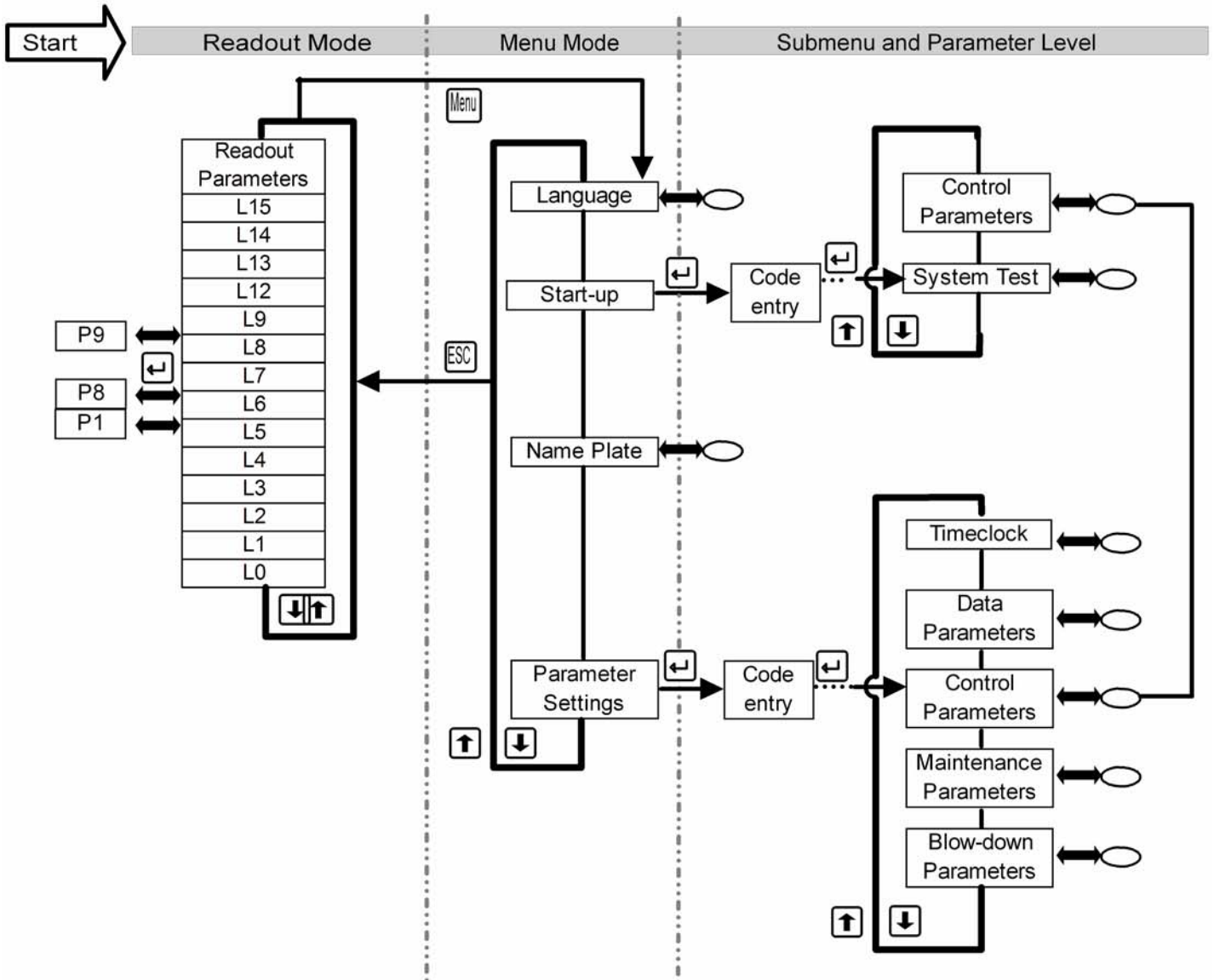

Explanation:

Toggle between Menu and Submenu

indicates transition to the next Submenu

... : are software keys in the control's display. They can be activated by pressing the keys below them.



Airtrend
Limited

Kumanovska 14, 11000 Beograd
Tel: +381 11 383 6886, 308 5740. Fax: +381 11 344 4113
e-mail: gobrid@eunet.rs • www.airtrend.rs