

HygroMATIK®

Operating manual

Softener device

WaterLine Compact



CE



WLC.EN

Copyright © HygroMatik GmbH 04.05.2015

WL-C EN

All rights reserved



Warning! Hazardous Voltage: All work to be performed by trained personnel only. All electrical installation and servicing of the electrical components of this unit to be performed by qualified electricians only. Disconnect power supply before installation and servicing!

1. Introduction	5
1.1 Intended Use	5
1.2 Typographic markings	6
1.3 Documentation	6
2. Safety instructions	7
2.1 General information	7
2.2 Safety instructions for the installation and start-up of the softener device	7
2.3 Safety regulations for the operation of the softener device	8
2.4 Safety instructions for working on electrical equipment	9
2.5 Disposal upon disassembly	9
3. Transport	10
3.1 General Information	10
3.2 Temporary storage	10
3.3 Inspecting for correctness and completeness	10
3.4 Scope of delivery	10
3.5 Packaging and return consignment	10
4. Functionality and device composition	11
4.1 Principle of operation	11
4.2 Device composition	11
4.3 Operating cycles	13
4.3.1 Softening	13
4.3.2 Regenerate	13
4.4 Brine	15
5. Installation	16
5.1 Basic prerequisites for operating the WaterLine softener device	16
5.2 Selecting the correct installation location of the Waterline softener device within the house installation scenario	16
5.3 Requirements on the installation site of the WaterLine softener device	17
5.4 Attaching the tubing for raw water and soft water	17
5.4.1 Prerequisites for the correct connection of the tubing on the softener device	17
5.4.2 Connecting the control valve to the house water installation	18
5.4.3 Connecting the control valve to the optional mounting block	18
5.5 Make waste water connection	19
5.6 Connecting the brine tank overflow	19
6. Start-up	20
6.1 Operating the control valve for the first time	20
6.2 Run forced regeneration	21
6.3 Filling the brine tank with salt tablets	21
6.4 Programming the control valve	21
6.5 Setting of the optional external blendingvalve	23

7. Programming of the control valve	24
7.1 General information	24
7.2 Overview on the display and operating options for the device operator (normal operation)	24
7.3 Programming steps for the control valve	25
7.3.1 Deactivating and re-activation of the valve lock	25
7.4 Settings	25
8. Maintenance	27
8.1 General information	27
8.2 Maintenance work to be carried out by the device operator	27
8.2.1 Daily check of proper device operation	27
8.2.2 Periodical inspection	29
8.2.3 Minor Maintenance	29
8.3 Full maintenance	31
8.4 Troubleshooting	31
9. Removal from service, storage and recommissioning	32
9.1 Removal from service	32
9.2 Storage	32
9.3 Recommissioning	32
10. Technical specifications WL-C-18	33
11. Spare parts	34

1. Introduction

Dear customer,

thank you very much for choosing a HygroMatik cabinet ion exchanger device (softener device).

In order to operate your HygroMatik softener device safely, properly and economically please carefully study this operation manual.

Only use your HygroMatik softener device when in flawless condition as well as according to its intended use, safety and hazard conscious and in compliance with all hints and restriction given in this operation manual.

For any further questions please contact HygroMatik as follows:

AIRTREND Limited
Predstavništvo u Beogradu
Kumanovska 14, 11000 Beograd
Tel: 011 383 68 86, 308 57 40
Faks: 011 344 41 13
e-mail: gobrid@eunet.rs
web: www.airtrend.rs

For any queries or ordering of spare parts please have your device data ready!

1.1 Intended Use

The HygroMatik cabinet ion exchanger device (softener device) is ment for the production of soft water. It may only be used according to its intended use.



Caution: Proper use includes fulfilment of the assembly, disassembly, reassembly, start-up, operating and maintenance conditions specified by us as well as disposal measures.

Only appointed qualified staff may work on or with the system. Persons transporting or working on or with the system must have read and understood the relevant parts of this operating manual, particularly the 'Safety instructions' section. Staff must also be informed of possible hazards by the operating company. Please keep a copy of the operating manual at the location where the device is being used.

Any **additional equipment** may only be built into any parts of the softener device with the written permission of the HygroMatik GmbH.

WaterLine softener device utilization

- The intended case of application is the operation within the area of **drinking water** supply.
- All TVO (Trinkwasserverordnung = Drinking Water Ordinance) **limit and guide values** must be respected. The

iron (Fe) content limit is 0.2 mg/l, max. manganese (Mn) is 0.05 mg/l

- For use with raw water with a **iron and/or manganese** content exceeding these limits, only HygroMatik WaterLine softeners of the WL-DP family type are suited
- The softener device must **not be operated outside** in the exterior
- **Frost protection** and **humidity protection** must be ensured
- Allowable **environmental temperature** is 5 - 40 °C with a max. r.h. of 60 percent
- Use of a **system separator** according to EN 1717 (former DIN 1998, part 4) is obligatory
- Optimum **flow pressure** of the device is 4.0 bar



Please note: For protection of the softener device, a **water filter** according to DIN 13443-1 implemented in front of the water intake is obligatory. Without such a filter the ion exchanger resin might silt-up within short periods of time. Also, the control valve might get damaged by dirt ingress.

1.2 Typographic markings

- lists with items beginning with bullets: general lists
- » lists with items beginning with arrows: work or operating steps which should or must be carried out in the specified order
- ☑ installation steps which must be checked
- italics* figure and plan names

1.3 Documentation

Storage

Please keep this operating manual in a safe place where it is accessible at all times. If you sell the product, be sure to include this manual. Please contact HygroMatik if the documentation is lost.

Language versions

This operating manual is available in different languages. Please contact your HygroMatik dealer or HygroMatik for details.

2. Safety instructions

2.1 General information

The safety instructions are prescribed by law. They are intended to ensure health and safety at work and accident prevention.

Warnings and safety symbols

The following safety symbols are used in this manual to indicate hazard and risk warnings. Please familiarise yourself with these symbols



Caution: Failure to heed this warning may result in injury or danger to life and limb and/or damage to the device.



Caution:Voltage: Dangerous electrical voltage! Failure to heed this warning may result in injury or danger to life and limb.



Indicates materials and consumables which must be handled and/or disposed of in accordance with statutory requirements.



Please note: precedes explanations for or cross-references to other places in the text. Also, information is marked in this way that requires particular observance.

General safety instructions for working on the HY-EKB20 softener device



Caution: Prior to working on the softener device water supply must be cut



Caution: The device may be under pressure. Prior to working on the device pressure must be released.

2.2 Safety instructions for the installation and start-up of the softener device

- Integration of the softener device into the house water installation scenario must only be carried out by an expert company for drinking water treatment. Local and regional regulations must be obeyed without exemption
- The electrical connection and programming of the softener device may only be made by trained personnel

- Please also consider **water flow pressure** in your supply situation. The allowable pressure range is 2.5 to 7.0 bar. If pressure lies above that, a pressure reducer must be installed
- As a **protection against water damage**, a gully is recommended. If not available, alternatively a water-stop may be used
- The installation ground must be imperatively level and dry. The device is to be placed in a way that tilting by accidental impact is not possible
- Please consider adequate **distance to heat sources**
- We recommend the sole use of pipes made from **plastic or stainless steel**. Zinc plated water pipes are not suited for use with zero hardness water

2.3 Safety regulations for the operation of the softener device

General

- Any form of using the device that impairs the safety of the device must be refrained from
- Please observe all safety and hazard signs on the device
- On functional failures switch-off the device immediately and secure against switching on again. Clear any faults on the spot
- After repair work operational safety must be assured by expert staff
- Only use original spare parts
- All other national regulations beyond the a.m. coverage apply without restriction for operating the device

Use by persons not entitled

This device is not intended for the use by persons (including children) with limited physical, sensoric or mental capabilities or lacking experience and/or non-existing knowledge unless supervised by a person responsible for the user's safety or prior instructions given in the use of the device. Children should be kept an eye on to make sure that no playing with the device happens.

Operational safety

- For your own safety regularly inspect connecting pipes and hoses to minimize the **risk of flooding**
- Check the brine tank in a regular time frame to make sure that **regeneration salt is always available** in sufficient volume in order not to limit the functional capability of the device

- To avoid contamination by dust or pest, the brine tank should always be closed with the appropriate **cover**
- Even when not in use for a longer period of time, the device should remain switched on since hygienic regenerations are run in stand-by also

2.4 Safety instructions for working on electrical equipment



Warning: Only expert personnel is permitted to work on the electrical system and the control cabinet (if applicable).



Risk of electrical shock! Prior to working on the electrical equipment of the softener device always cut the mains connection by unplugging the power adaptor. Make sure never to touch electrical components with wet hands.

Switch off the system immediately if faults in the electrical energy supply occur.

Only use original fuses with the specified amperage.

Inspect the system's electrical equipment at regular intervals. Promptly eliminate deficiencies, such as loose connections or melted cables. After carrying out the corresponding electrical assembly or maintenance work, test all protective measures used (e.g. earth resistance).

Accident prevention regulations



Caution: Heed the HSW (Health and Safety at Work) regulations for electrical installations and equipment (VBG4/BGVA3). By doing so you protect yourself and others from harm.

2.5 Disposal upon disassembly



The operating company is responsible for disposal of the system parts in accordance with statutory requirements.

3. Transport

3.1 General Information



Please note: Take care when transporting the HygroMatik softener device to prevent the device and packaging from being damaged.



Warning: Pressure tanks are very impact sensitive und must not be rolled.

3.2 Temporary storage

Store the device in a dry and frost-free place.

3.3 Inspecting for correctness and completeness

When you receive the goods, ensure that the equipment is complete and all parts are in perfect condition.



Please note: Any transport damages and/or missing parts must be reported immediately to the shipper or supplier.

The periods in which notification of the transport company must occur for the purposes of identifying the damage are as follows*:

Transport company	Time after receipt of goods
Post	no later than 24 hours
Rail	7 days at the latest
Rail and road transport companies	4 days at the latest
Parcel services	immediately

* Periods are subject to change without notice.

3.4 Scope of delivery

The following items are included in the delivery:

- Softener device (in case of a device featuring two pressure tanks, the second tank is separately packaged)
- Operating manual(s)
- Accessories ordered

3.5 Packaging and return consignment

Should return consignment be necessary, please consider the following:

- Preferably use euro pallet for packaging
- Ensure frost and humidity protection during transport
- Take care when handling pressure tanks

4. Functionality and device composition

4.1 Principle of operation

The HygroMatik softener device makes use of the ion exchange method for replacing magnesium and calcium by sodium, thus producing so called soft water. The device works using the concurrent process and was designed for normal salting (partial salting is possible as well).

After the production of a set volume of soft water, regeneration occurs on a regular base. For that purpose brine water is sucked from the brine tank into the exchanger (pressure tank). Because of the extremely high concentration of sodium in the brine the hardness components bound are exchanged again with sodium. The regeneration waste water is drained to a canal. On finishing the regeneration cycle, the brine tank is filled-up again with water to allow for the production of new brine.

Besides the volume based regeneration, forced regeneration is carried out on a regular base according to DVGW (Deutscher Verein des Gas- und Wasserfaches e.V.) to ensure proper hygienic conditions. Otherwise, the softener may be prone to microbial contamination if no water flow exists due to longer periods of non-usage (e.g. during holiday periods) Pre-setting for forced regeneration is 3 days. This setting may be changed by the operator.

4.2 Device composition

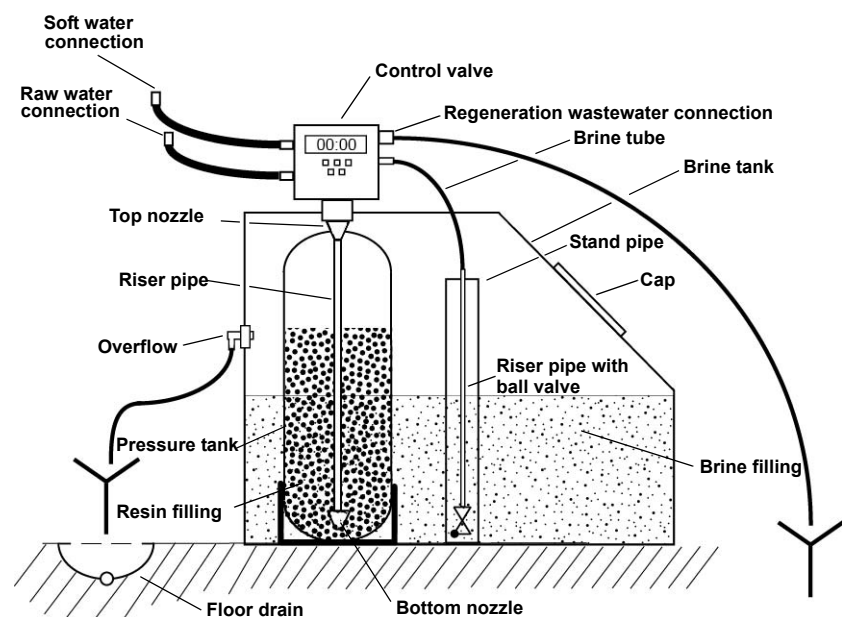

Principle design of WaterLine softener device WL-C



Control valve for WL-C, view

The device is composed of a cabinet with the ion exchanger holding the resin filling (pressure tank made from GRP) integrated into the brine tank. Built into the pressure tank is a riser pipe with a bottom and a top nozzle. On top of the pressure tank sits the control valve.

Arranged in the brine tank is a stand pipe holding a riser pipe for brine sucking. The bottom end of the riser pipe features a ball valve that blocks sucking when the brine level has sunk accordingly. The riser pipe top end is connected to the control valve through a brine tube.

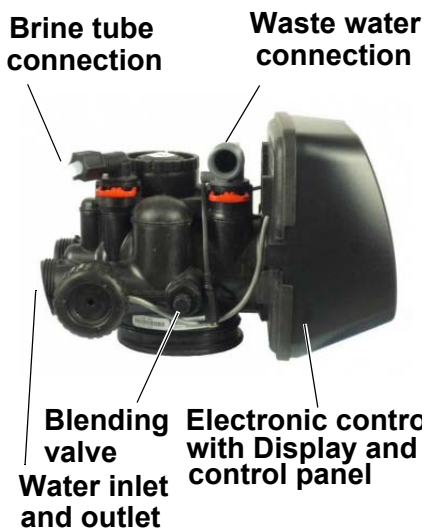

Control valve for WL-C, connections

The control valve is connected to the house water installation either directly or via a (optionally available) mounting block through hoses for water inlet and water outlet (optionally available water connection set including titration kit may be used). The hose connections make use of the provided BSPT adaptors (BSPT = British Standard Pipe Thread).

The waste water hose is connected to a 3/4 inch elbow on the control valve. Draining must feature an open outlet in order to prevent microbiological contamination.

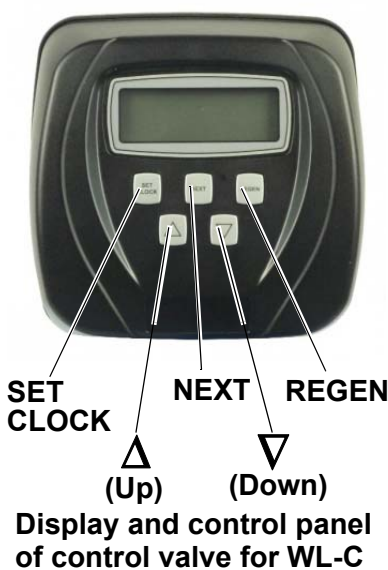

Display and control panel of control valve for WL-C

The control logic comprises a display for time-of-the-day presentation as well as the preset and programmable parameters of the ion changer process. Operating and programming is accomplished by use of the 5 keys designated „SET CLOCK“, „NEXT“, „REGEN“ as well as „Δ“ und „∇“ (up/down-arrows for increasing/ decreasing settings).

4.3 Operating cycles

Normal operation mode of the WaterLine softener devices is „softening“ . Alternating to this (in case of single systems) or in parallel (with double systems), then in the currently not active exchanger, „regenerating“ is carried out. The following operating cycles can be distinguished in detail:

Normal operation

- Softening

Regeneration

- Backwash
- Brine and Slow wash
- Rinse
- Fill (brine tank)

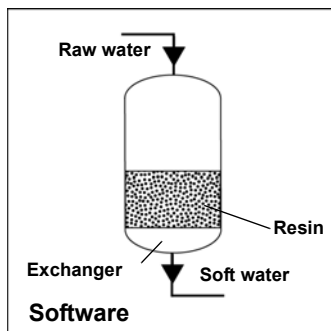

4.3.1 Softening

This is the normal operation mode of the WaterLine softener device. The control valve guides raw water into the pressure tank filled with exchanger resin. Raw water flows top down through the resin while the resin absorbs magnesium and calcium ions, exchanging them with sodium ions. By this mechanism, softened water is generated. The product water enters the rise pipe in the pressure tank through the bottom nozzle and is subsequently propagated to the control valve and, finally, to the consumer through the product water pipe.

4.3.2 Regenerate

Since the exchange capacity of the resin is exhausted after a certain volume of soft water produced, regeneration is required on a regular time frame. For this purpose, NaCl brine is used that is produced by dissolving salt tablets in the brine tank.

Regeneration point of time is determined by the control valve. To enable this, „soft water capacity“ with respect to the Waterline device capacity and local raw water hardness must be programmed into the the control valve logic. On reaching the threshold set, automatic regeneration will result. The number of regeneration occurrences is only restricted by resin life time.



Please note: The dimensioning of the WaterLine softener device must be such that soft water demand does not exceed the soft water capacity between any two regenerations.

The regeneration process is separated in the partial steps „backwash“, „brine/slow wash“, „rinse “ and „fill“.

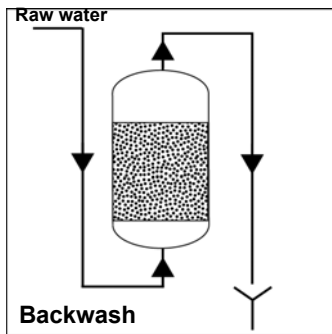

4.3.2.1 Backwash

Under control valve regime raw water is fed bottom up through the exchanger resin in the pressure tank, thus causing disaggregation of the resin.

4.3.2.2 Brine and slow wash

In the brine tank, a 25 percent brine is prepared from raw water and NaCl.



Please note: Building up the required brine concentration takes 6 hours of time minimum. Such, any two regenerations should be separated by at least this time interval.

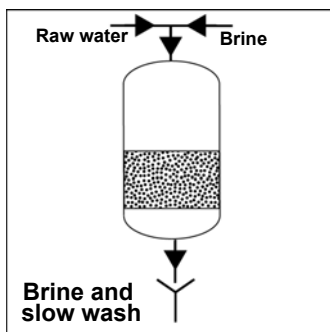

Brine is sucked up by the control valve injector and blended with raw water to a 10 to 12 percent concentration, which is the optimum concentration for the regeneration process. The diluted brine is fed through the resin top down. Now ion exchange takes place in the inverted direction as compared to softening, setting free and draining calcium- and magnesium ions bonded by the resin. Following brining, slow wash is carried out in the following way: When no more brine is sucked by the injector, only raw water flows through the resin bed in the pressure tank. Any brine left in the pressure tank is swamped out by and by.

4.3.2.3 Rinse

Following slow wash, rinse is carried out with raw water guided through the pressure tank top down at a rate of approx. 8 - 12 m/h. After a flushed water volume corresponding to 3 to 4 times the resin filling volume, proper soft water may again be produced.

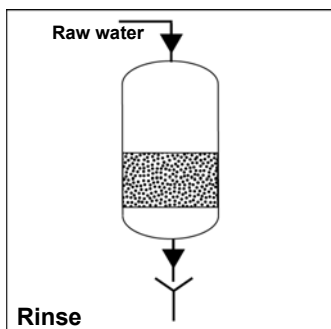

4.3.2.4 Fill

The brine tank is filled-up automatically with a defined volume of water. After filling the regeneration process is terminated and the control valve sets the WaterLine softener device back to normal operation.

4.3.2.5 Duration of the regeneration steps

Duration of the individual regeneration steps may be programmed by the operator (s. chapter 7 for details). Typical recommended settings are as such:

Backwash: 3 - 5 mins.

Brine/Slow wash: total time 45 mins. (brine is fully sucked-up in approx. half of the time)

Rinse: 5 - 8 mins.

Fill: this „time“ is not set in minutes but is expressed by the salt volume (in kg) needed per regeneration event. For determination of the amount of salt, resin volume [l] (see technical specifications) must be multiplied by 160 g/l for partial brining or 220 g/l for full brining.

For the WaterLine softener device WL-C-18 with a resin filling of 4.5 l, full brining requires $4.5 \times 220 \text{ g/l} = 0.99 \text{ kg}$ of salt.

Practical fill time for the WaterLine WL-C-10 is approx. 1:20 mins.

4.4 Brine

The capacity of a WaterLine softener device is not a constant but is determined by the following factors:

- Raw water quality (drinking water quality required)
- Raw water hardness
- Raw water hardness variations (require regular checks)
- Raw water flow pressure
- Resin quality
- Resin volume
- Method of brining

These influencing variables must be considered when programming the control valven. Below, particular attention is directed on the method of brining.

Depending on the amount of NaCl consumed during regeneration, full or partial brining is referred to. For a residual hardness of soft water below 0.1 °dH, only full brining is adequate. Full brining requires the use of 220g of salt per liter of resin.



Please note: When working with zero hardness water, zinc-coated pipes must not be used. Only pipes made from plastic or stainless steel are adequate.

In case of a lower requirement concerning the residual hardness, partial brining (i.e. 160g of salt per liter of resin) is allowable.



Please note: When using partial brining, a certain „slip of hardness“ may occur, i.e. following a regeneration soft water hardness may be increased by 2°dH (with respect to the set value) for a certain amount of time.

5. Installation

5.1 Basic prerequisites for operating the Water-Line softener device

The following requirements must be met for operating the Water-Line softener device:

- Electrical connection requires on-site fusing and must not be interrupted at any time (connection to branch circuit not permissible)
- Minimum flow pressure must be 2.5 bar
- Maximum flow pressure must not exceed 7.0 bar. Optimum is 4.0 bar
- Temperature in operating room must be between 5 °C and 40 °C
- R.h. in operating room must not exceed 60 percent
- The drain provided by customer must be a free outlet according to EN DIN 1717
- The operating room must be sufficiently ventilated, must allow for the floor loading introduced by the WaterLine softener device and feature a floor gully.

5.2 Selecting the correct installation location of the Waterline softener device within the house installation scenario

- If no mounting block is used, the house installation tubing must be cut at a suitable spot (downstream of the pressure reducer, if applicable) and the Waterline softener device must be inserted
- For insertion of a mounting block approx. 300 mm of free tubing is required
- Should a water filter not be installed yet, another 300 to 400 mm of free tubing for installation of a filter must be considered

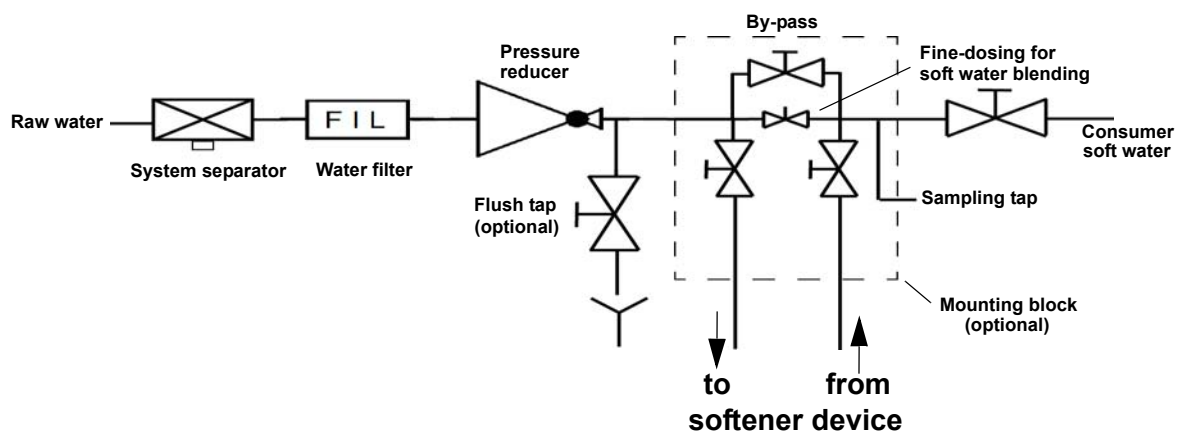

Principle connection of HygroMatik WaterLine WL-C-18 softener device by means of the optional mounting block

5.3 Requirements on the installation site of the WaterLine softener device

- The floor must be even and dry and have a load capacity that reflects the operating weight of the softener device as given in the technical specifications. An even floor is mandatory in order to allow for a tensionless arranging of the tubing for the device
- The WaterLine softener device must be levelled on-site. For securing the system against tilting by inadvertant impacting, a wall mounting set is available as an option (Article no. B-5000105)
- The floor must be clean and free of pointed objects, stones, construction waste etc. in order not to pose any damaging hazard to the brine tank.
- If required set-up a fundament
- A sewer junction must be in close proximity
- For safety reasons the installation location should feature a floor gully. If no gully exists, a water stop may alternatively be used.

5.4 Attaching the tubing for raw water and soft water

5.4.1 Prerequisites for the correct connection of the tubing on the softener device

- Raw water flow pressure must be 2.5 bar minimum. If not the case, proper functioning of the WaterLine softener device may be impaired by air cushions that may built up. For monitoring flow pressure, it makes sense to integrate a manometer into to the raw water pipe, if not already present.
- Any installations (such as elbows etc.) upstream of the softener device that may reduce flow pressure are not allowable
- Max. flow pressure must never exceed 7.0 bar. If a pressure situation, pressure peaks or hydraulic shocks beyond 7.0 bar may be encountered, a pressure reducer must be implemented upstream of the softener device.
- Raw water supply must always be secured by use of a system separator according to EN DIN 1717
- A filter in the raw water pipe is indispensable in order to prevent foreign matter to be washed into the control valve possibly causing malfunctioning
- A rinsing valve just shortly upstream of the softener is recommended. Rinsing the pipe after installing armatures prevents debris such as pieces of kindling or impermeable material to enter der WaterLine softener device
- On-site tubings must be supported by adequate means in

WL-C control valve, connections for water, waste water and brine

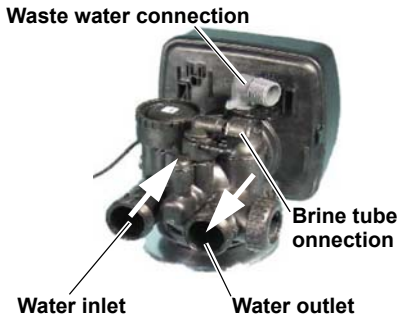

order to avoid tensions in the tubing system

- We recommend the use of pipes made from plastic or stainless steel.. Zinc-plated pipes are not suitable for use with zero hardness water.

5.4.2 Connecting the control valve to the house water installation

- » Use adequate hoses incl. flat gaskets to connect water inlet and water outlet of the control valve to the house water installation. Make sure to pay attention to the flow direction arrows on the control valve indicating water inlet and water outlet
- » Check all connections for leakiness

For connecting, the optionally available „Water connection set comprising 2 hoses and titration kit, art. no. B-5000103“ may be used.

5.4.3 Connecting the control valve to the optional mounting block

After installation of the optionally available mounting block (Article no. E-5000072), water inlet and water outlet valves must be closed in the first step and the by-pass valve must be open in order not to break house installation raw water supply. The set screw for blending fine-dosing must be screwed in fully clockwise (blending valve closed).

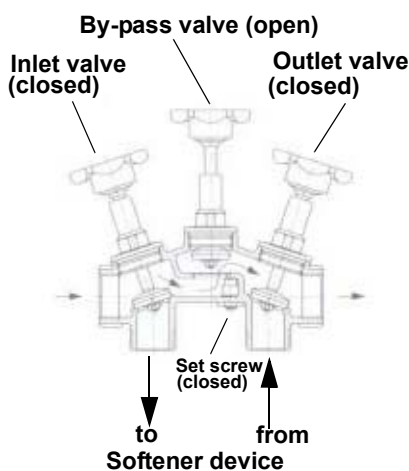

By-pass setting of the optional Anschlussarm

- » Use adequate hoses incl. flat gaskets to connect water inlet and water outlet of the control valve to the house water installation. Make sure to pay attention to the flow direction arrows on the control valve indicating water inlet and water outlet
- » Open water inlet valve on mounting block while the valve in the middle remains closed (by-pass still open). Now drinking water is fed to the softener device via the mounting block
- » Check all connections for leakiness

Please note: The water outlet valve of the mounting block must not be opened prior to start-up of the softener system in order not to allow any water from the softener to enter the house installation before clean soft water is produced.

5.5 Make waste water connection



- » Disconnect connecting nut from control valve waste water elbow and push onto PVC waste water hose provided with the system. The hose end holds a inner detonator shell for stabilizing purposes.
- » Insert waste water hose into waste water elbow on control valve and screw-on connecting nut hand-tight
- » Attach waste water hose with free outlet in order to prevent microbial contamination hazard
- » lay hose without cross-section reduction or kinks

The optionally available waste water connection set (article no. E-5000040) may be used for connection.



Please note: Hazard of backflow! Make sure that the waste water sees a permanent decline when routed to the drain. In case of a drain situated higher then the control valve the use of a backflow flap is a must.

5.6 Connecting the brine tank overflow

A brine tank overflow hose is not provided with the WaterLine softener device. A proper hose must be provided by the customer. The hose provided for waste water draining may be cut in two and the second hose piece may be used for overflow connection.

As is the case with waste water, overflow also needs a free outlet.

6. Start-up



Warning: The system may only be started-up by qualified staff.

- » Close shut-off valve(s) of soft water outlet
- » Make fused mains connection close to installation location
- » Be aware that electrical connection must not be interrupted at any time (do not use branch circuits intended for lighting)



Warning: Do not yet fill any salt into the brine tank. This may only be made after start-up, since otherwise water level in the brine tank cannot be set correctly.



Warning: In order not to allow any (possibly contaminated) water from the softener device enter the house water installation before the first forced regeneration was run, the shut-off valve towards house installation must be initially kept closed. In a next step, forced regeneration should be carried out in order to drain the water fed through the softener device directly to the canal.

6.1 Operating the control valve for the first time

Following the plugging-in of the power adapter, the time of day display on the control valve will flash. Before executing any other steps the system clock may be set.

Setting the clock

- » Press the *SET CLOCK* key („SET TIME“ will be displayed and the hour digits will flash)
- » Change the value shown using the Δ and ∇ arrow keys
- » Press the *NEXT* key for saving and advancing to minutes' input (digits will flash)
- » Change the value shown using the Δ and ∇ arrow keys
- » Press the *SET CLOCK* key again in order to finish clock setting; when done so, the display will show „TIME“

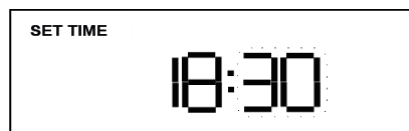
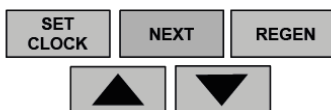
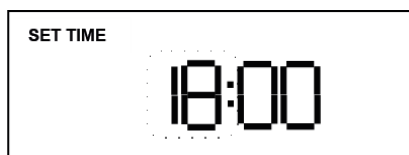

6.2 Run forced regeneration

Before using the WaterLine softener device for the first time, a rinse and regeneration process of approx. 40 mins. of duration should be carried out for the a.m.reason. During this period some noise will be perceived due to the motorized valve piston movement and water flowing through the control valve and the tubing.

- » Open raw water supply to the softener device
- » Press and hold the *REGEN* key on the control valve for 3 secs. in order to start forced regeneration

During regeneration process execution, the current state is indicated by displaying the denomination of the individual step performed in that instant. The whole cycle is through when the display shows „Time“ again and the digits reflect time-of-the-day.

- » Visual inspection: Check all pipes, tubes and hoses for leakiness

A the end of the regeneration process, the control valve triggers the filling a few liters of water into the brine tank required for generation of the brine to be used by the next regeneration.

6.3 Filling the brine tank with salt tablets

- » Fill-up the brine tank with salt tablets at least to a level that makes the residual water in the tank fully disappear (filling-up to the max. capacity of the tank is harmless).



Please note: The salt needs min. 6 hours for dissolving. Only tablet salt complying with EN 973 should be used.

6.4 Programming the control valve



Please note: The WaterLine softener device was provided with the parameters specific for the system (e.g. the exchanger resin capacity) during the manufacturing process already. Beyond that, some inputs on local influencing values are required from the system operator. Among these are local water hardness, the required degree of blending (to yield e.g. 4 °dH of soft water hardness) and the defined time point of regeneration.



Please note: Programming steps beyond the scope given below are described in chapter 7 (programming of the control valve).

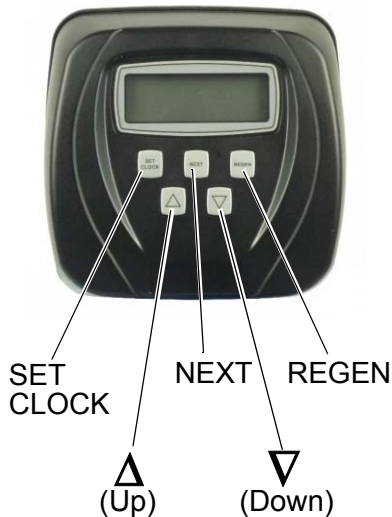

Aktivation of input mode

- » Press and hold the *NEXT* and Δ keys simultaneously for 3 seconds. The display will show the raw water hardness set by factory

Input of local water hardness

- » Use the Δ and ∇ arrow keys for setting the actual raw water hardness or leave the setting unchanged, if appropriate
- » Press the *NEXT* key for saving and preparing the input of the next parameter (mixed water hardness, „hardness 2“)

Setting mixed water hardness

The control valve features an integrated blending valve, the use of which, however, is not recommended by HygroMatik. Instead, an external blending valve (see chapter 6.5) should be employed. If so, mixed water hardness must be set to „zero“ on the control valve.

- » Set hardness2 to zero by means of the arrow keys
- » Press the *NEXT* key for saving and preparing the input of the next parameter (forced regeneration)

Additional information on the use of the integrated or of an external blending valve

Since the blending valve integrated in the control valve works not very precisely when used with a low flow rate, HygroMatik generally recommends the use of an external blending armature that works independent from pressure. When such a valve is in use, setting the mixed water hardness to „zero“ is mandatory for correct determination of the residual capacity by the control valve.

Should the operator nevertheless decide to use the integrated blending valve, the hardness resulting from blending (and as measured with the help of a hardness measurement kit) must be programmed into the control valve. This value is not an actuating variable for the blending valve but serves solely for the residual capacity determination in combination with other available data. The hardness measurement kit (titration kit) is part of the optionally from HygroMatik available water connection kit.

Setting forced regeneration in [days]

This parameter defines the number of days after which a forced regeneration shall be carried out. Factory setting is „3 days“.

When pressing the *NEXT* after the step prior to the current one , setting the forced regeneration parameter is enabled:

- » Use the Δ and ∇ arrow keys for setting the days or leave the setting unchanged, if appropriate
- » Press the *NEXT* key for saving and preparing the input of the next parameter (forced regeneration time of day setting)

Setting time of the day for forced regeneration

Factory setting for forced regeneration time is 2.00 a.m.- a time of day when typically no demand for water by a consumer exists.. When pressing the *NEXT* key in the step prior to the current one, input of time of day was enabled:

- » Use the Δ and ∇ arrow keys for setting the time of day or leave the setting unchanged, if appropriate
- » Press the *NEXT* key for saving and exiting input mode

Beenden der Programmierung

By pressing the *NEXT* key in the step described above, programming of the control valve was finished and the display returned to normal „Time“ mode.

Changing the factory settings of further parameters

Settings beyond the basic settings described here may be made by service personnel. For that purpose, a dedicated programming manual is available from Hygromatik.

6.5 Setting of the optional external blending-valve



Please note: When using the optionally available external mounting block (Mounting block with integrated blending valve, art. no. E-5000072), pls follow the recommendations given in the operating instructions leaflet provided with the article.



Please note: For operating HygroMatik steam humidifiers, a mixed water hardness of 4 °dH is recommended for electrode humidifiers. For operating heater humidifiers pls. contact HygroMatik first.

In case of an inverted osmosis device downstream of a Water-Line ion exchange softener, zero-degree soft water is required. Such, no raw water is blended to the soft water.

7. Programming of the control valve

7.1 General information



Please note: If the control valve was cut from mains for a longer period of time there is a delay of about 30 secs before the control piston is driven to its basic position. The display will blink showing the time-of-the-day format as a request for the time to be set.

Programming is done by means of the 5 keys on the control panel (*SET CLOCK*, *N*, *REGEN*, Δ and ∇).



Please note: Any input or display step invoked by pressing the *NEXT* key may be cancelled by pressing the *REGEN* key without any other effect. Finishing an input step within a particular programming level will automatically make the control proceed to the next step in the order documented here.

7.2 Overview on the display and operating options for the device operator (normal operation)

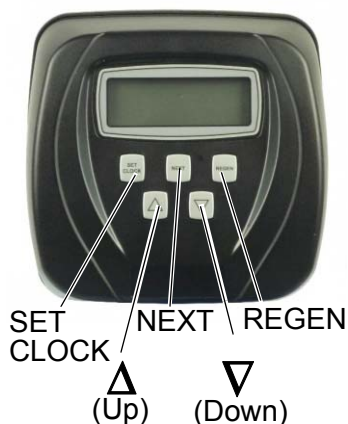

Starting with the time-of-the-day display on this level the user may only change the time setting, view the current water flow or the remaining capacity or initiate manual regeneration (when the system is in softener mode) or rinse (when in filtration mode) at the time set or immediately.

In normal operation the display shows „TIME“ and the time of the day. Using the *NEXT* key allows for scrolling through all of the other views.

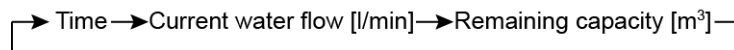

Use *NEXT* key

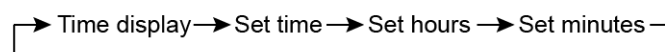

Use *SET CLOCK* / *UP* / *DOWN* / *NEXT* / *SET CLOCK* keys

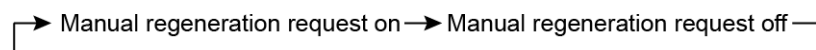

Use *REGEN* key (press and hold for 3 s for immediate execution)

7.3 Programming steps for the control valve



Please note: Should the control valve refrain from reacting to inputs of any kind, the valve lock may be active.

7.3.1 Deactivating and re-activation of the valve lock

In order to prevent any unintended setting of the control valve parameters, a valve lock can be engaged.

Disengage valve lock

- » Sequentially press ∇ , NEXT, Δ and SET CLOCK keys. Display will show „DISPLAY UNLOC“

Engage valve lock

- » For re-engaging the valve lock, exactly repeat the step described above. Display will show „DISPLAY LOC“.

7.4 Settings

Step 1: Set time of the day

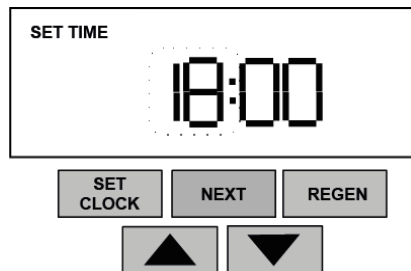

- » Press the *SET CLOCK* key („SET TIME“ is displayed and the hour field is blinked)
- » Change the setting using the Δ and ∇ arrow keys
- » Press the *NEXT* key for storage und to advance to the minutes setting (the minutes field is blinked)
- » Change the setting using the Δ and ∇ arrow keys
- » Press the *SET CLOCK* key again for storage and exiting time of the day setting; the display returns to „TIME“

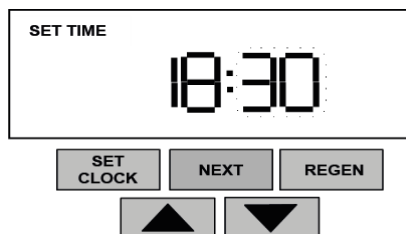

Step 2: View current water flow

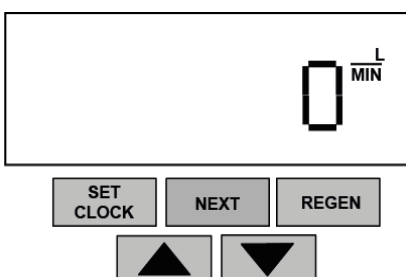

- » Starting fro „TIME“ display press the *NEXT* key; the current water flow l/min is displayed
- » Press the *NEXT* key for the next step or *REGEN* to return to the previous display. i.e. time-of-the day

Step 3: View the remaining capacity (available amount of treated water)

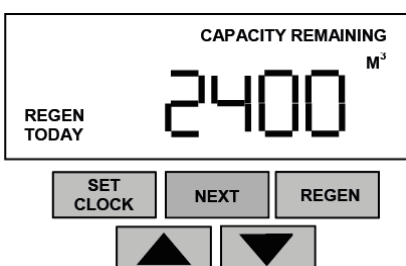

- » When pressing the *NEXT* key to finalize the previous step the display shows „CAPACITY REMAINING“ and the amount of softened water in [M³] is displayed
- » Press the *NEXT* key for returning to the time-of-the-day display or *REGEN* to go back to the previous step

Step 4: Triggering an ahead of schedule regeneration/ rinse cycle on reaching the time set for the first time

This action will be executed independantly from the remaining capacity

- » Press the *REGEN* key; the display will blink „REGEN TODAY“ as an indication for the „waiting“ regeneration cycle
- » Pressing *REGEN* again cancels the requested action

Step 5: Triggering an instantaneous regeneration/rinse cycle

- » Press and hold the *REGEN* key for für 3 secs; control will position the valve piston for execution of the first cycle defined. The display will show „REGEN“ and the corresponding cycle number (starting with the first cycle) and the cycle denomination. Additionally, the set cycle duration will be displayed and decreased as the cycle is executed

At the start of a cycle the display is blinked for a few seconds. After finishing a particular cycle the next cycle defined is automatically invoked. When the last cycle is done the control valve will return to normal operation.



Please note: All cycles may be exited at any time and the next cycle in the programmed order be started

- » Press the *REGEN* key for aborting the current cycle and commence the next one

8. Maintenance

8.1 General information

The HygroMatik softener device requires only very little maintenance by design. In order to guarantee the water quality desired, however, periodically performed checks of the device are important. Daily control of proper operation is just one activity to start with. Beyond that, an extended life-time of the HygroMatik WaterLine softener device may only be achieved when programmed maintenance is carried out.

With respect to standards and regulations relevant for drinking water supplies, we recommend that the following intervals are met:

- bimonthly inspection of the device by the device operator
- minor maintenance every 6 months by the device operator
- full maintenance once per year by an expert company for water treatment



Warning: When carrying out maintenance works pls. keep in mind:

- only expert staff may do the maintaining
- always obey security regulations
- Prior to maintenance work shut-down operation of device and secure system against switching on (pull power adaptor)
- After finishing maintenance work, have device checked for operational safety by expert personnel

8.2 Maintenance work to be carried out by the device operator

8.2.1 Daily check of proper device operation



Visual inspection

Check device for leakiness. Leaking components should be made tight by technical staff. No kinks are allowed in feeding or draining hoses.

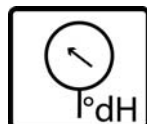

Check raw water hardness

In case of a deviation from set value, settings may be required to be changed by technical staff.

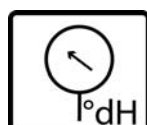

Check soft water hardness

In case of a deviation from set value, settings may be required to be changed by technical staff.



Check salt tablet supply

A certain amount of salt must always be detectable in the brine tank in order to ensure the availability of the 25 percent brine required for the regeneration of the exchanger resin. The latest instance for filling up the salt tablet supply is when the liquid level exceeds the salt level.

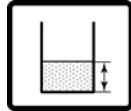

Refill salt

It is recommended to refill salt tablets up to the lower rim of the feed opening when the amount of salt consumed corresponds to approx. one quart of the total tank volume.



Attention! Make sure not to introduce any contamination into the brine tank since this may impair water quality. When refilling salt, hygienically flawless proceeding must always be ensured.



Please note. For **hygienic** reasons the following precautionary measures must be taken:

- Store the regeneration salt exclusively in a dry and clean place
- Preferably, do not use open packages or bags
- Clean the package or bag outside before opening it
- Fill the brine tank only directly with salt from the package or bag
- Under all circumstances, close the brine tank carefully with the cap provided for this purpose!



Please note: In case of a regeneration cycle without the adequate brine concentration (i.e. 25 percent), one more regeneration cycle is required for single softener devices after the 6 hours of wait time for the salt tablets to dissolve. Double softeners require two regeneration cycles because of the two pressure tanks.

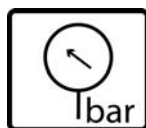

Check operating pressure of the softener device

Flow pressure must lie within specified tolerance (see technical specifications).

8.2.2 Periodical inspection

In addition to the daily checks, the activities described below should be carried out at bimonthly intervals:



- Check leakiness of wastewater connection on control valve**

No wastewater to be detected on connection elbow



- Check filter insert of fine filter in raw water pipe and replace if contaminated or visible wear detectable**

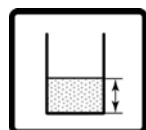

- Check brine consumption during regeneration as indicated by salt filling level change in brine tank.**

Unsufficient salt consumption may indicate that brine sucking is disordered. In this case the injector and injector screen cage must be cleaned (see chapter „Minor maintenance“). Also, check brine tube for leakiness.

8.2.3 Minor Maintenance

These works should be carried out every 6 months:



- Exchange filter insert in raw water fine filter**

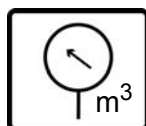

- Read and record water meter display**

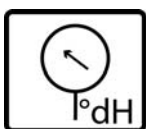

- Determine raw water and soft water hardness**

Use water hardness kit.



- Check time-of-day and raw water setting on control valve**

In case of a deviation of more than 1°dH between the raw water value measured and the value set, the control valve setting must be corrected.



- Clean injector and injector screen cage**

For these works the injector cap(1) on he control valve must be dismounted. Use the service spanner (6) provided with the device to loosen the screw connection

- » Dismount injector cap (1) on control valve
- » Remove and clean injector (5)

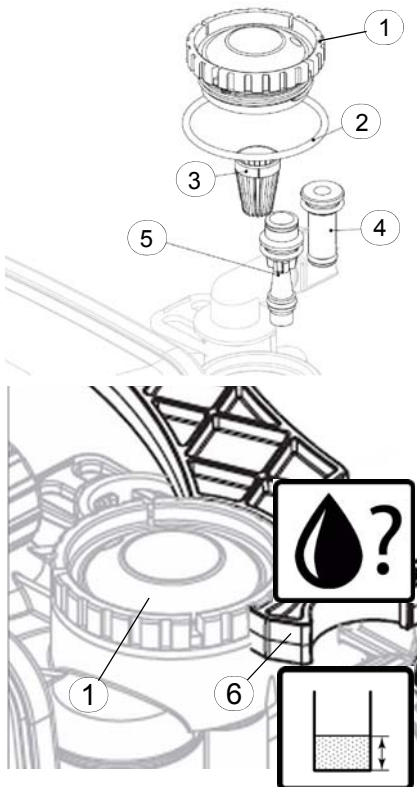

- » Remove and clean injector screen cage (3)
- » Reinsert screen cage and injector and refit injector can (hand-tight only)

- 1 - Injector cap
- 2 - O - ring
- 3 - Injector screen cage
- 4 - Injector assembly Z plug
- 5 - Injector
- 6 - Service spanner wrench

Check leakiness of complete device (including drain)

Check salt tablet supply in brine tank und fill up, if required

(s. Kap. 8.2.1)

Check salt consistency in brine tank

The salt must not be agglutinated (if required, break up clumping with an appropriate tool or dissolve using hot water)

Check leakiness of brine tube and replace, if required

8.3 Full maintenance

With respect to EN 1717 (was: DIN 1988 part 8/A12) a complete maintenance program should be carried out once per year by an expert company for water treatment.

The maintenance procedure for the annual maintenance effort is described in a document of its own that may be received from HygroMatik upon request.

8.4 Troubleshooting

Problem	Possible cause	Solution
Device not lively	Mains disruption	Check whether power adapter is plugged in; check fusing; make sure that mains connection is disruption-free
Water remains hard	By-pass valve open	Close by-pass valve until desired blended hardness is accomplished
	No salt in brine tank	Fill-in salt
	Injector contaminated	Clean injector and screen cage
Salt consumption too high	Brine FILL parameter wrongly set	Correct FILL programming Contact expert company for drinking water treatment
Loss of capacity	Salt type inadequate	Only use approved pure salt
	Raw water hardness has changed	Check raw water hardness and correct control valve setting, if required
	Brine concentration too low	Allow salt to dissolve for at least 6 hours before start of regeneration
Water is drained during softening	Control valve piston not in operating position	Check control valve; press NEXT and REGEN keys simultaneously for 3 seconds to reset control valve
General error code on control valve	Control valve not properly functioning	Check control valve; press NEXT and REGEN keys simultaneously for 3 seconds to reset control valve (call expert for interpretation of error code)

9. Removal from service, storage and recommissioning

9.1 Removal from service



Please note: Even when the device is not used for longer periods of time, it should remain switched-on since hygienic regenerations are run in stand-by as well.

Should for good cause removal from service should nevertheless be required, the steps below must be performed.

Work is comprehensive and should only be carried out exclusively by an expert company for drinking water treatment.

- » For a last operational cycle, run resin regeneration
- » Completely remove resin from pressure tank
- » Wash pressure tank with water and let dry
- » Flush pipes and hoses with water and let dry
- » Clean control valve with water and let dry
- » Empty brine tank, flush and let dry
- » Let dry remaining salt and, subsequently, store in a dry place

9.2 Storage

- » Store resin in moist condition, protect against drying-up
- » Store resin frost-free
- » Store salt inventory and remaining salt from brine tank in a dry place
- » Keep pressure tank(s) away from sun in order to prevent aging
- » Store pressure tank(s) shock-proof
- » Store control valve and power adapter in a dry place
- » Retain small components within clean and dry brine tank
- » Keep a copy of this operating manual close to the device

9.3 Recommissioning

Recommissioning is carried out in the same way as initial start-up was.

10. Technical specifications WL-C-18

Unit type	WL-C-18	
Device specification		
Minimum flowrate	l / min	1
Capacity	m ³ x °dH	18
Corresponding soft water output @ 10 °dH	Liter	1800
Resin volume	Liter	4,5
Required amount of salt (NaCl) per regeneration		
Full brining	kg	1
Partial brining	kg	0,7
Regeneration salt amount required per liter of resin		
Full brining	kg	0,22
Partial brining	kg	0,16
Water consumption per regeneration	Liter	50
Dimensions, weight and class		
Operational weight	kg	35
Weight of device	kg	15
Protection class	IP	54
Connections		
Electrical connection	VAC/Hz/VA	230/50 /50
Min. raw water flow pressure	bar	2,5
Max. raw water flow pressure	bar	7
Min. raw water temperature	°C	5
Max. raw water temperature	°C	30
Raw water inlet connection	Zoll	1
Soft water outlet connection	Zoll	1
Min. drain diameter	Zoll	1/2
Installation location requirements		
Max. environmental temperature	°C	40
Max. relative humidity	%	60
Approx. Depth	mm	500
Approx. width	mm	400
Approx. height	mm	600

11. Spare parts

WL-C/S/D/DP	Article No.	Description
1	E-5000046	O-ring 228
1	E-5000048	WS1 Spacer stack assembly
1	E-5000050	Injector black
1	E-5000064	Hose for WaterLine 1" IT, 700 mm, Nut 90°/1", Nut BSP
1	E-5000066	Hardness monitoring unit
1	E-5000068	Filter housing 1" IT, 9 3/4" - 2,5"
1	E-5000070	Filter candle 100 µm, set of 2 pcs.
1	E-5000072	Mounting block 1" incl. sampling cock, differential pressure balance and blending valve
1	E-5000074	Pressure reducer R 1" with manometer
1	E-5000076	System separator BAR 1" DN25 incl. connection fitting and discharge connection
1	E-5000086	Service spanner wrench
1	E-5000088	Free flow valve 1" with drain
1	E-5000040	Wastewater connection set according to DIN EN 1717
1	E-5000090	Funnel syphon white DN 50 according to DIN EN 1717
1	B-5000105	Wall mounting set for WaterLine (WL-S/D/DP only)
When ordering pls. specify type of unit as well		

This page intentionally left blank



HYGROMATIK[®]

AIRTREND Limited

Predstavništvo u Beogradu

Kumanovska 14, 11000 Beograd

Tel: 011 383 68 86, 308 57 40

Faks: 011 344 41 13

e-mail: gobrid@eunet.rs

web: www.airtrend.rs